

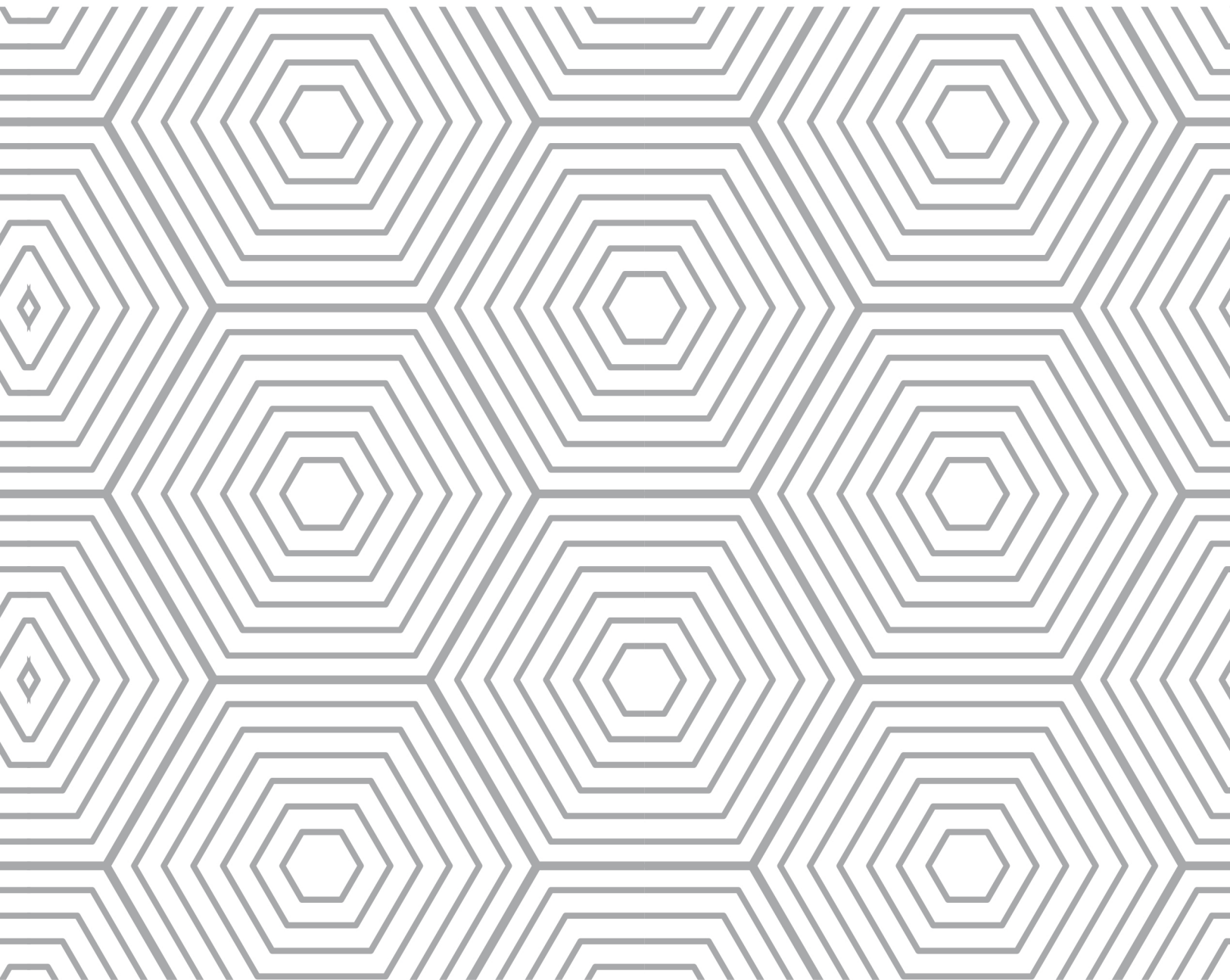

HIDAYATH

ETCH 
PATTERN CATALOGUE

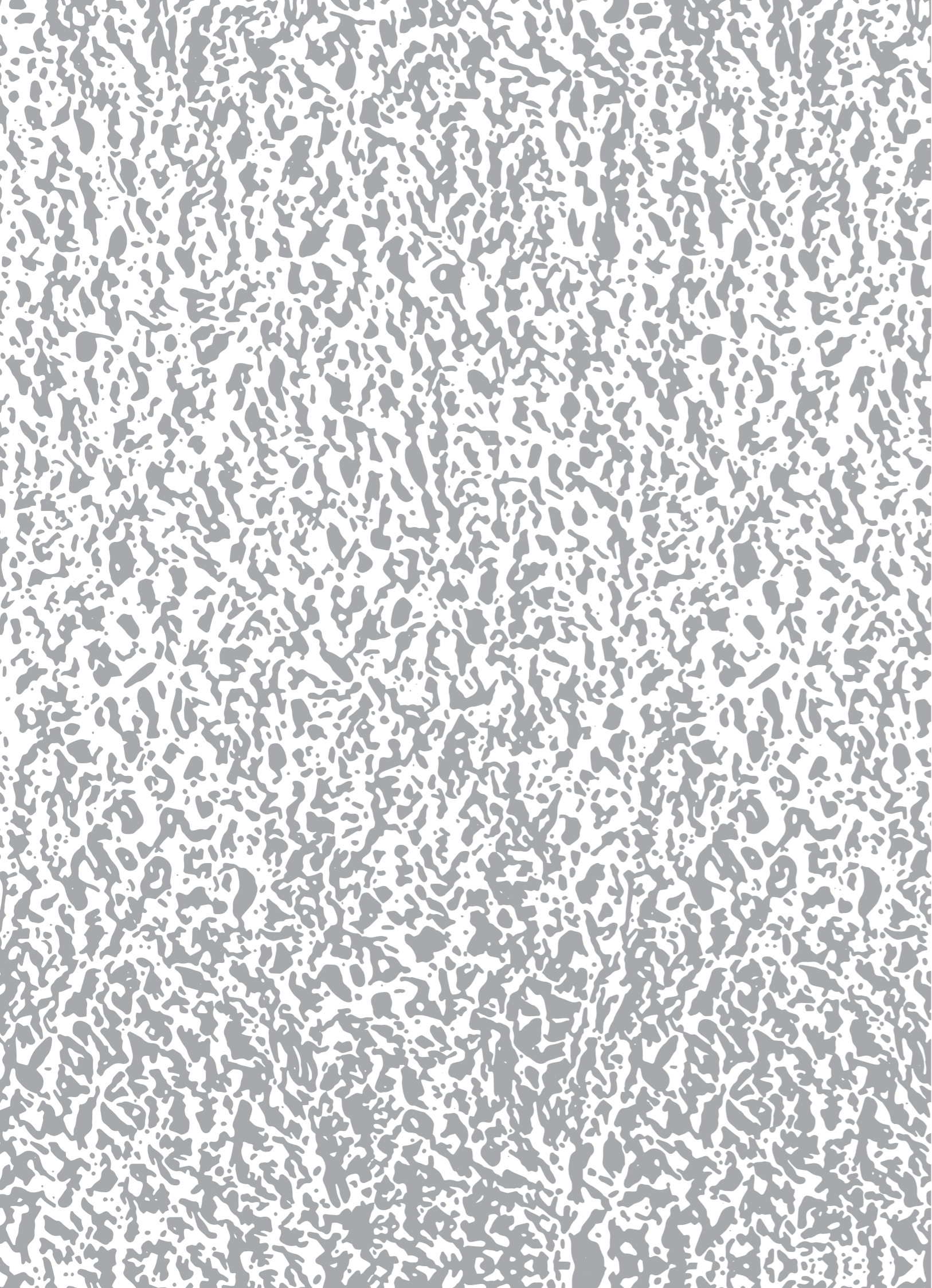



ETCH PATTERN

HISTORY & CONCEPT

HISTORY

Etching by goldsmiths and other metal-workers in order to decorate metal items such as guns, armour, cups and plates has been known in Europe since the Middle Ages, and may go back to around fifteenth century little earlier than the birth of etching as a printmaking technique.

The process as applied to printmaking is believed to have been invented by Daniel Hopfer (circa 1470–1536) of Augsburg, Germany. Hopfer was a craftsman who decorated armour in this way, and applied the method to printmaking, using iron plates.

CONCEPT

Wet etching is achieved with the use of chemicals that eat away the exposed surface creating a matt, dull finished area with the contrasting base finish.

These finishes are most attractive when used with a contrasting base finish. (Eg. Brush with Etching or Mirror with Etching, etc.

Please tour through the catalogue to view the different design patterns we have readily available. Custom designs can also be made after approval of design by our production department.

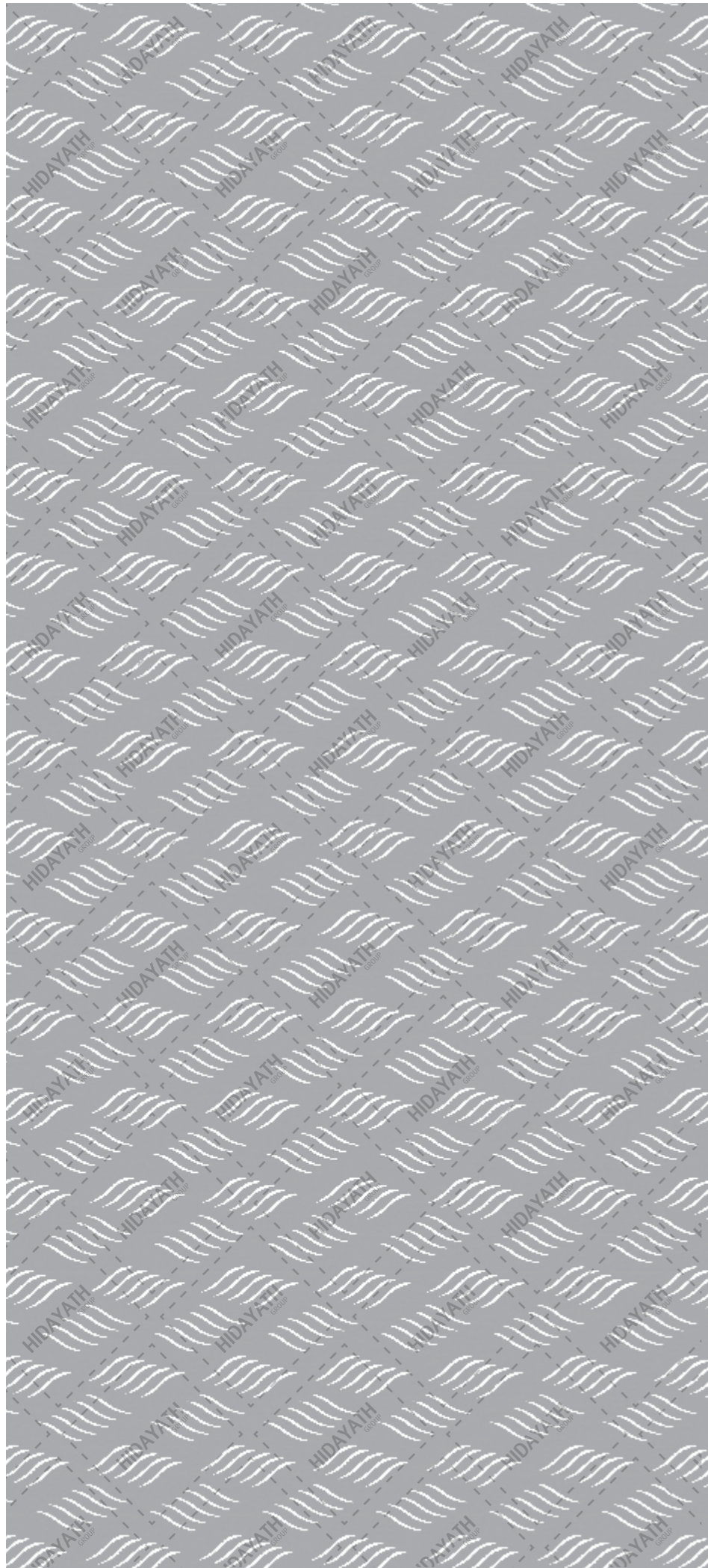

CODE
HTC 1003

Full sheet pattern orientation - **white** areas are etched.
Maximum Size: 8ft. x 4ft. (Etching)

Different finishes and colours are available on request.

Designs may be Waterjet cut or Laser cut as per requirement. Some designs may come with borders.

For detailed information kindly consult our sales personnel.

Note: The displayed illustration is for orientation only. Actual pattern may vary from the pattern shown.

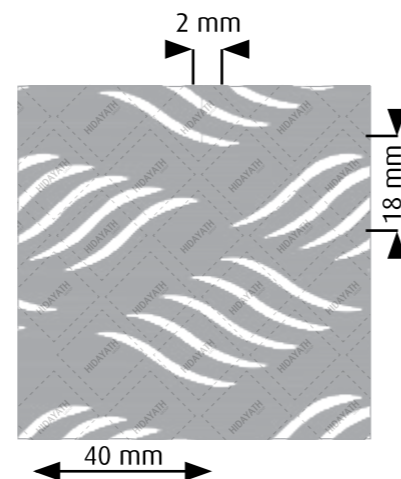

CODE
HTC 1004

Full sheet pattern orientation - **white** areas are etched.
Maximum Size: 8ft. x 4ft. (Etching)

Different finishes and colours are available on request.

Designs may be Waterjet cut or Laser cut as per requirement. Some designs may come with borders.

For detailed information kindly consult our sales personnel.

Note: The displayed illustration is for orientation only. Actual pattern may vary from the pattern shown.

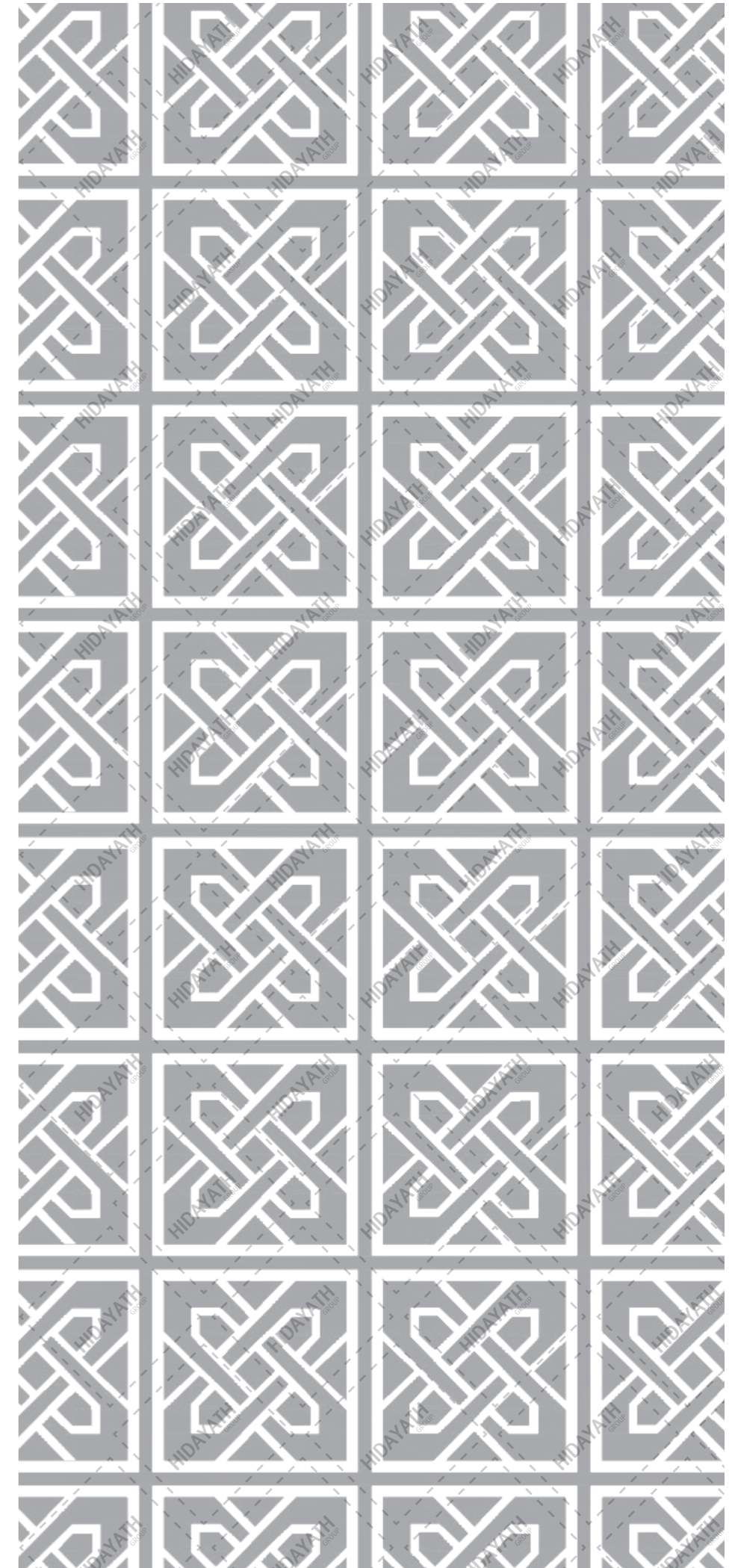
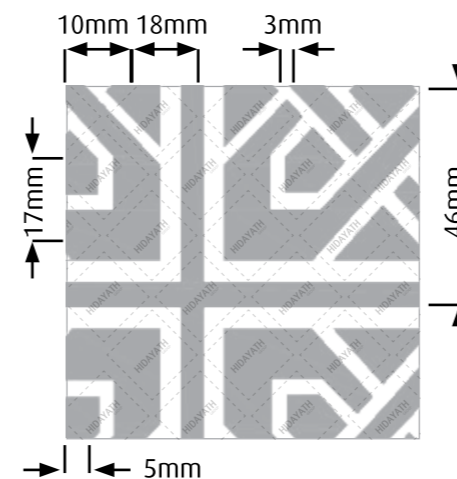



CODE
HTC 1005

Full sheet pattern orientation - **white** areas are etched.
Maximum Size: 8ft. x 4ft. (Etching)

Different finishes and colours are available on request.

Designs may be Waterjet cut or Laser cut as per requirement.
Some designs may come with borders.

For detailed information kindly consult our sales personnel.

Note: The displayed illustration is for orientation only. Actual pattern may vary from the pattern shown.

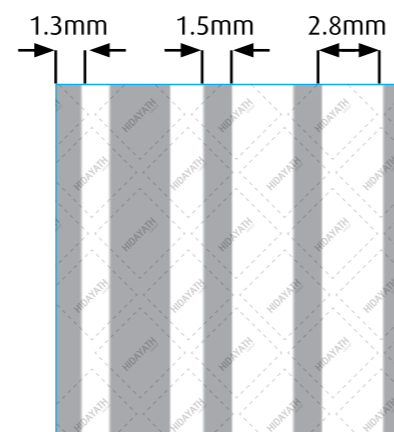

CODE
HTC 1009

Full sheet pattern orientation - **white** areas are etched.
Maximum Size: 8ft. x 4ft. (Etching)

Different finishes and colours are available on request.

Designs may be Waterjet cut or Laser cut as per requirement.
Some designs may come with borders.

For detailed information kindly consult our sales personnel.

Note: The displayed illustration is for orientation only. Actual pattern may vary from the pattern shown.

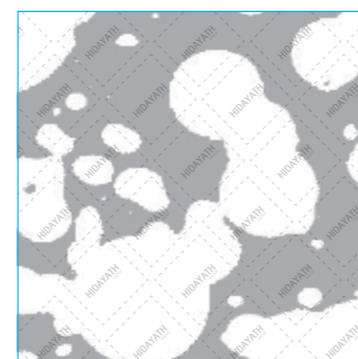

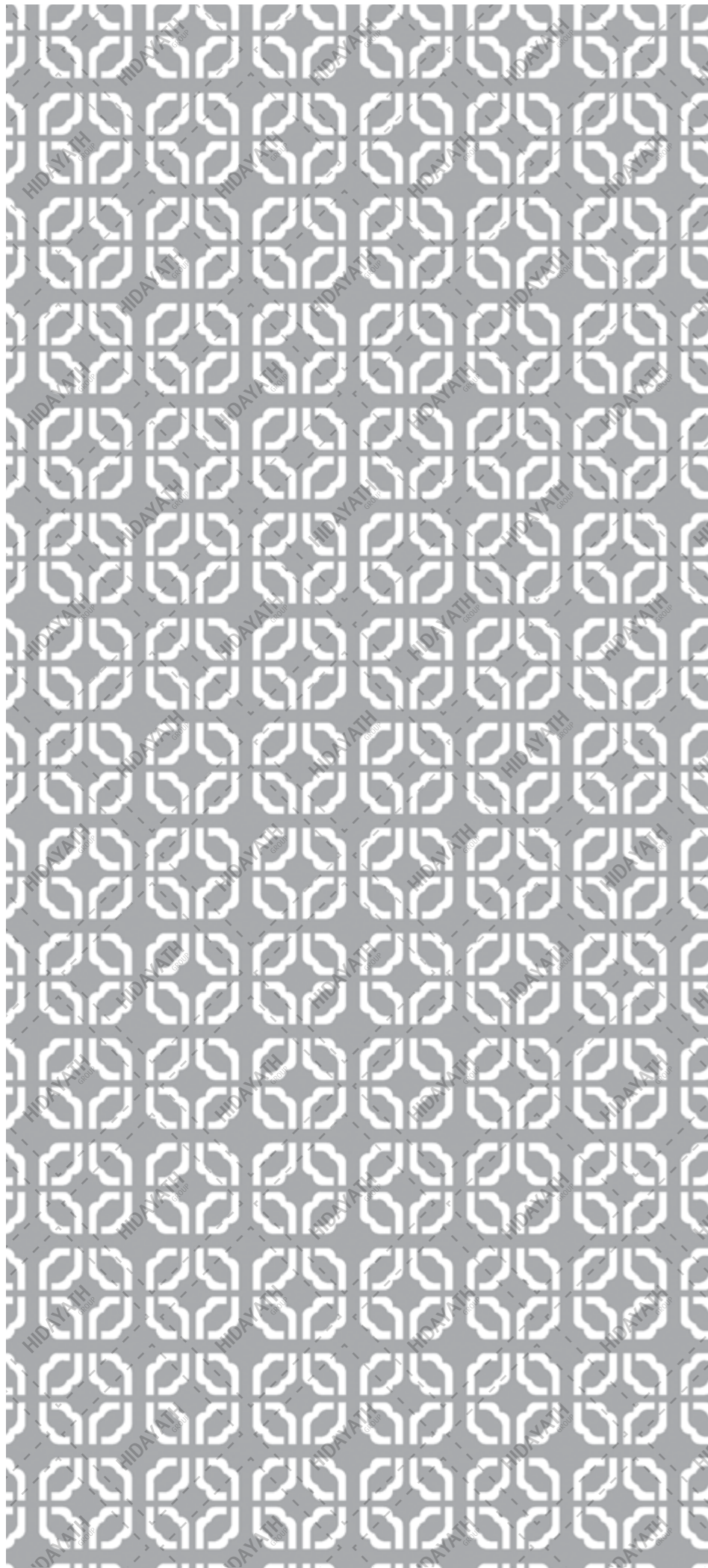

CODE
HTC 1011

Full sheet pattern orientation - **white** areas are etched.
Maximum Size: 8ft. x 4ft. (Etching)

Different finishes and colours are available on request.

Designs may be Waterjet cut or Laser cut as per requirement. Some designs may come with borders.

For detailed information kindly consult our sales personnel.

Note: The displayed illustration is for orientation only. Actual pattern may vary from the pattern shown.

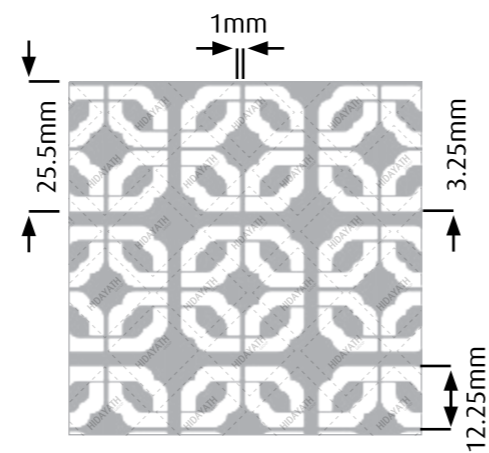

CODE
HTC 1012

Full sheet pattern orientation - **white** areas are etched.
Maximum Size: 8ft. x 4ft. (Etching)

Different finishes and colours are available on request.

Designs may be Waterjet cut or Laser cut as per requirement. Some designs may come with borders.

For detailed information kindly consult our sales personnel.

Note: The displayed illustration is for orientation only. Actual pattern may vary from the pattern shown.

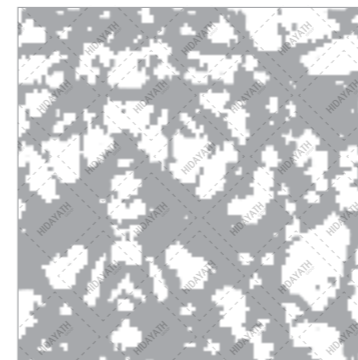

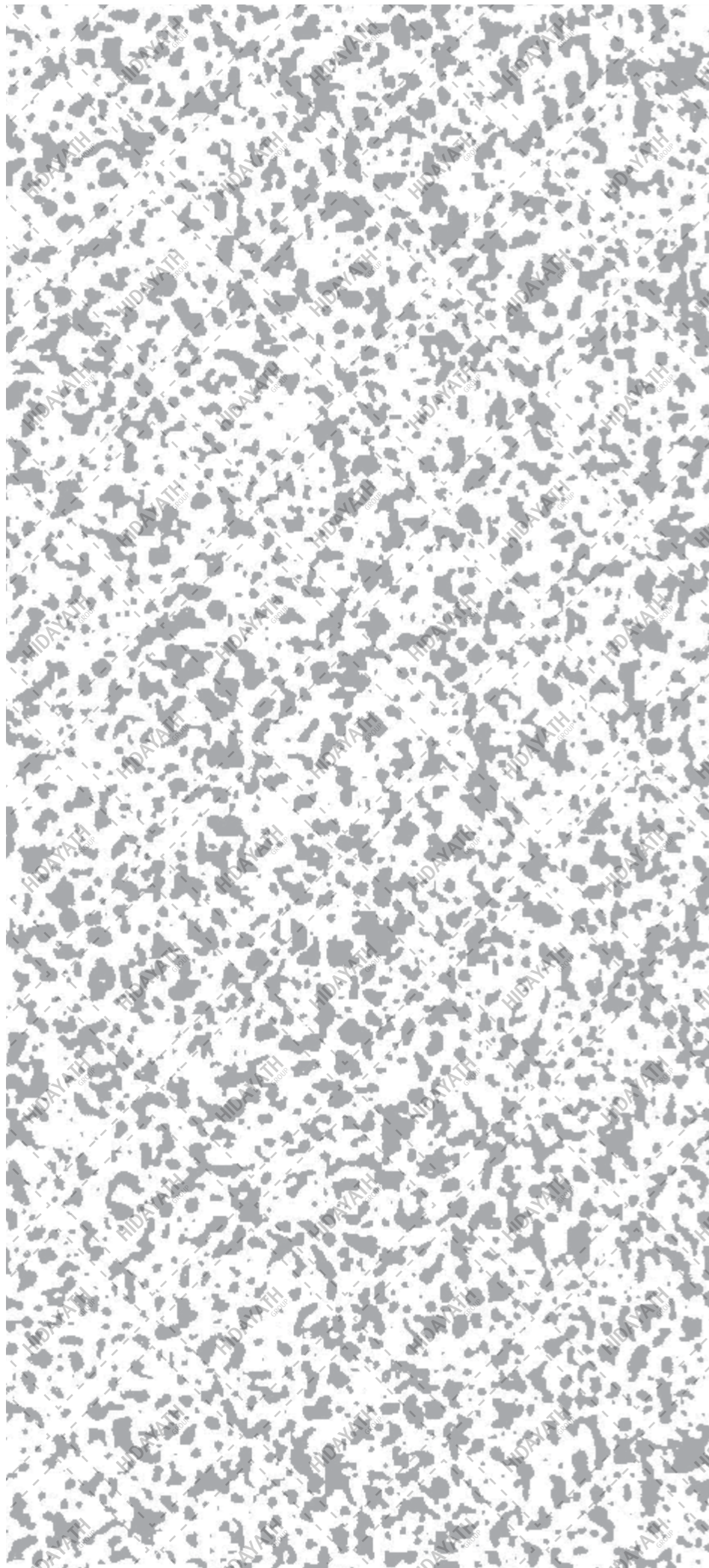

CODE
HTC 1013

Full sheet pattern orientation - **white** areas are etched.
Maximum Size: 8ft. x 4ft. (Etching)

Different finishes and colours are available on request.

Designs may be Waterjet cut or Laser cut as per requirement. Some designs may come with borders.

For detailed information kindly consult our sales personnel.

Note: The displayed illustration is for orientation only. Actual pattern may vary from the pattern shown.

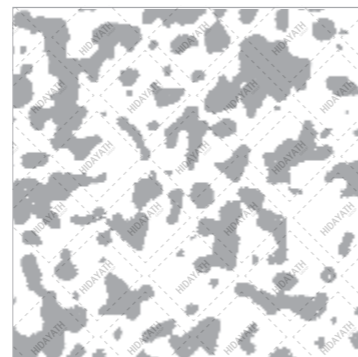

CODE
HTC 1015

Full sheet pattern orientation - **white** areas are etched.
Maximum Size: 8ft. x 4ft. (Etching)

Different finishes and colours are available on request.

Designs may be Waterjet cut or Laser cut as per requirement. Some designs may come with borders.

For detailed information kindly consult our sales personnel.

Note: The displayed illustration is for orientation only. Actual pattern may vary from the pattern shown.

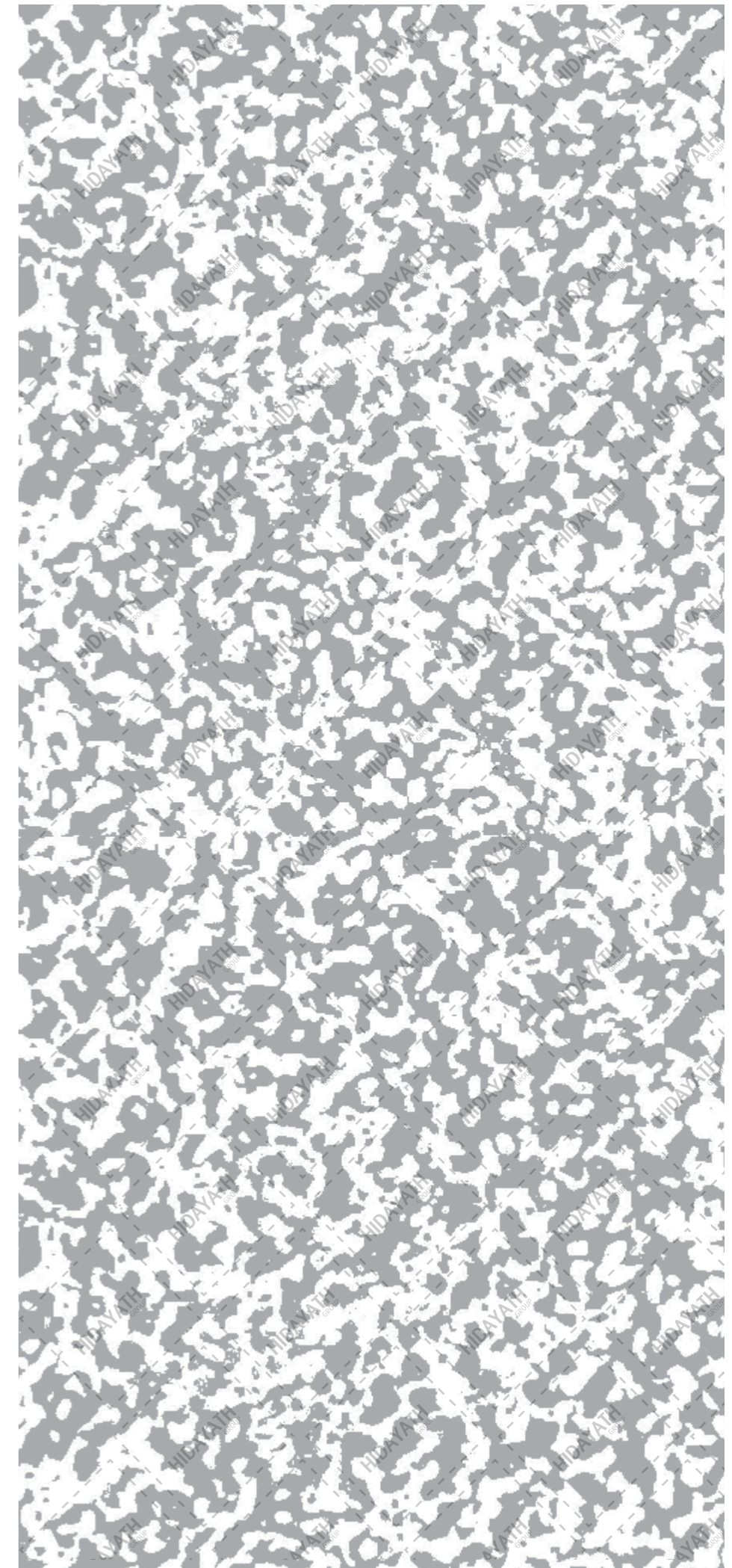

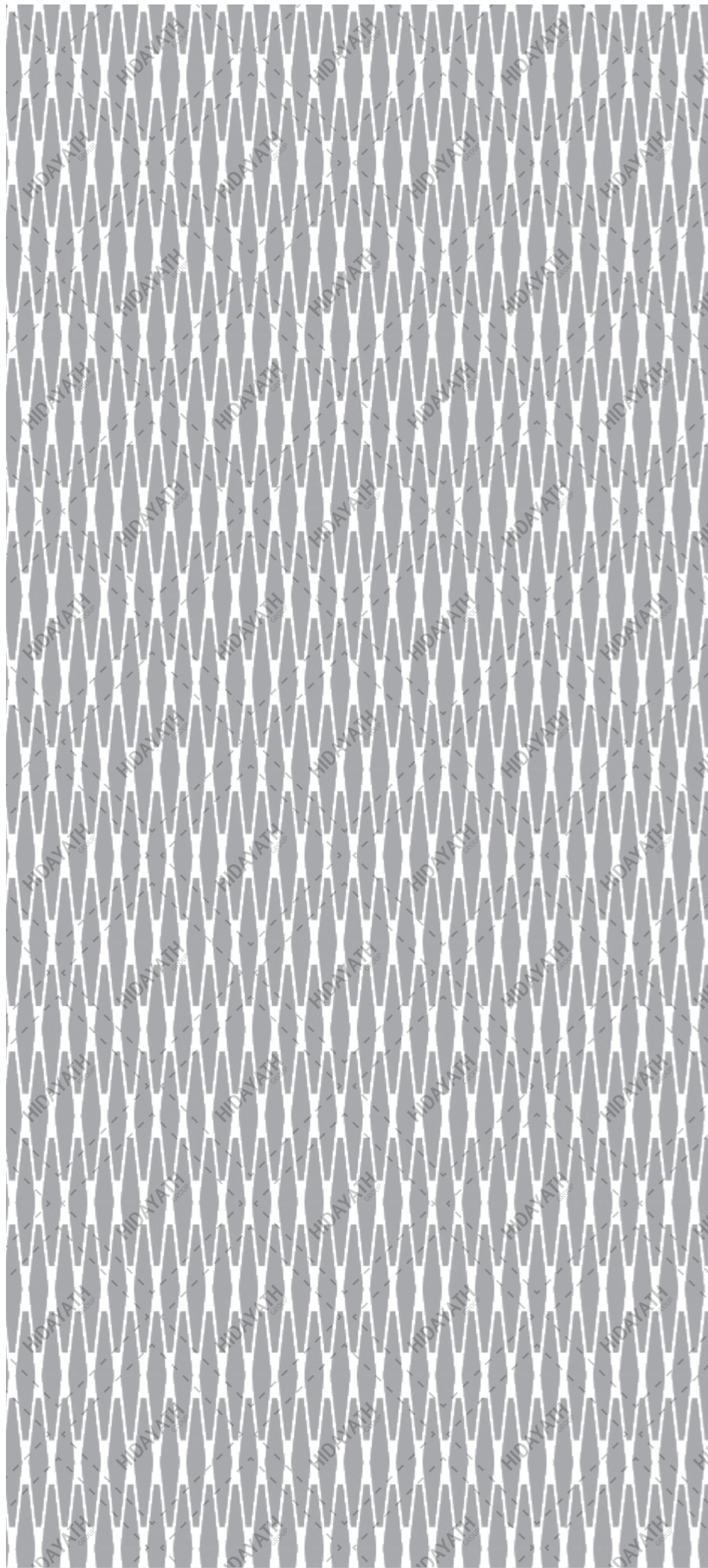

CODE
HTC 1016

Full sheet pattern orientation - **white** areas are etched.
Maximum Size: 8ft. x 4ft. (Etching)

Different finishes and colours are available on request.

Designs may be Waterjet cut or Laser cut as per requirement. Some designs may come with borders.

For detailed information kindly consult our sales personnel.

Note: The displayed illustration is for orientation only. Actual pattern may vary from the pattern shown.

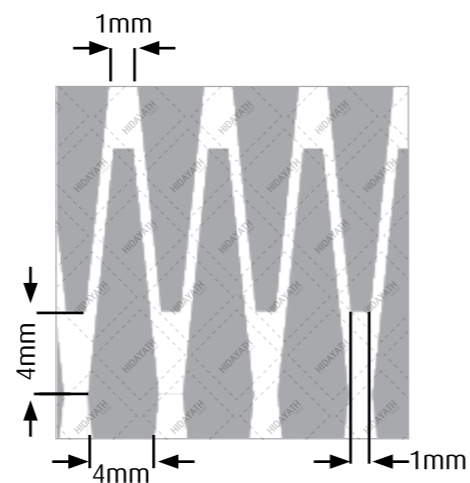

CODE
HTC 1017

Full sheet pattern orientation - **white** areas are etched.
Maximum Size: 8ft. x 4ft. (Etching)

Different finishes and colours are available on request.

Designs may be Waterjet cut or Laser cut as per requirement. Some designs may come with borders.

For detailed information kindly consult our sales personnel.

Note: The displayed illustration is for orientation only. Actual pattern may vary from the pattern shown.

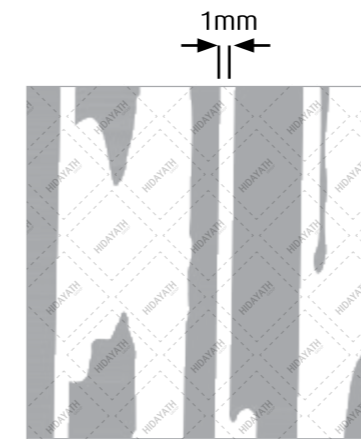

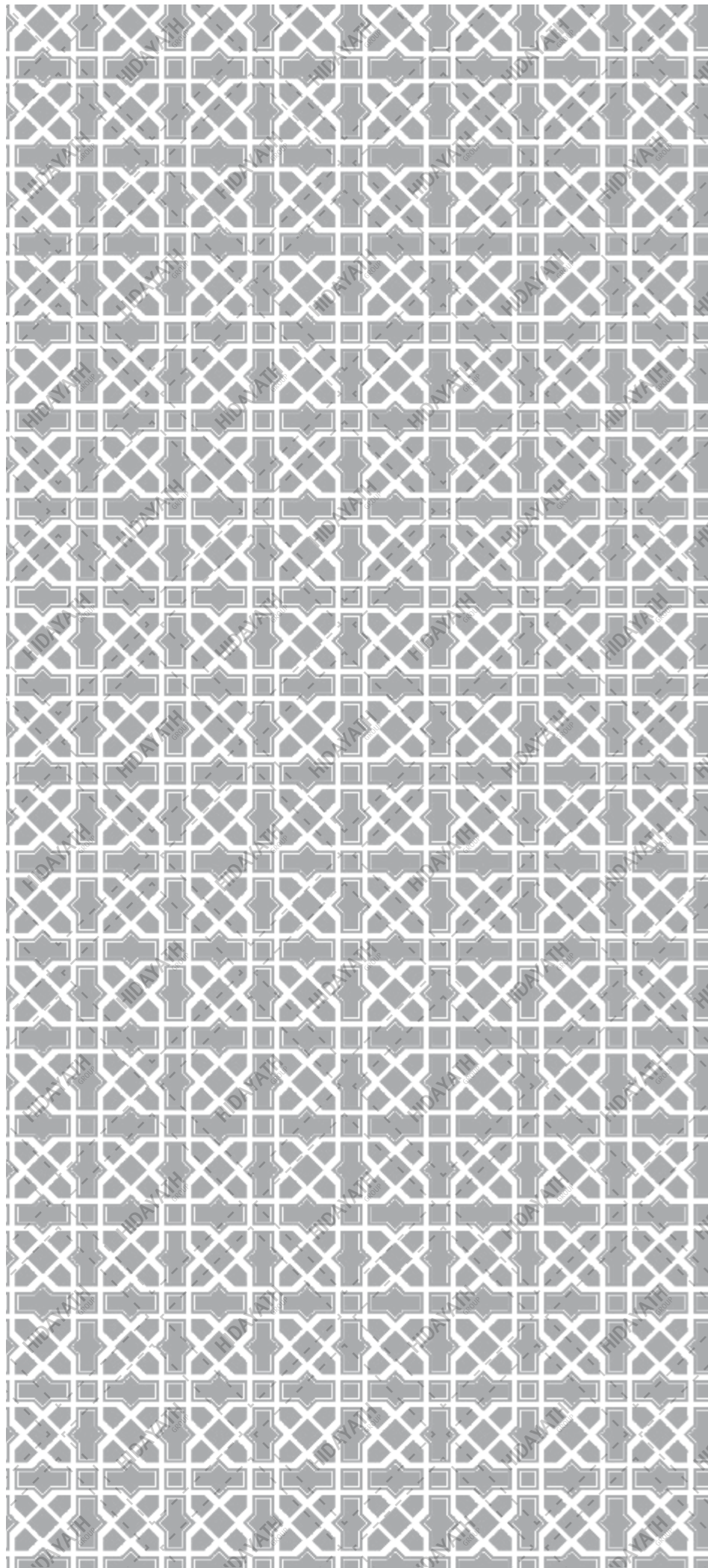

CODE
HTC 1018

Full sheet pattern orientation - **white** areas are etched.
Maximum Size: 8ft. x 4ft. (Etching)

Different finishes and colours are available on request.

Designs may be Waterjet cut or Laser cut as per requirement. Some designs may come with borders.

For detailed information kindly consult our sales personnel.

Note: The displayed illustration is for orientation only. Actual pattern may vary from the pattern shown.

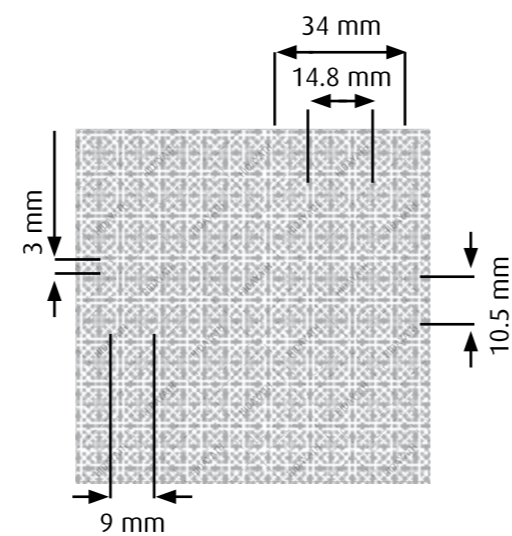

CODE
HTC 1019

Full sheet pattern orientation - **white** areas are etched.
Maximum Size: 8ft. x 4ft. (Etching)

Different finishes and colours are available on request.

Designs may be Waterjet cut or Laser cut as per requirement. Some designs may come with borders.

For detailed information kindly consult our sales personnel.

Note: The displayed illustration is for orientation only. Actual pattern may vary from the pattern shown.

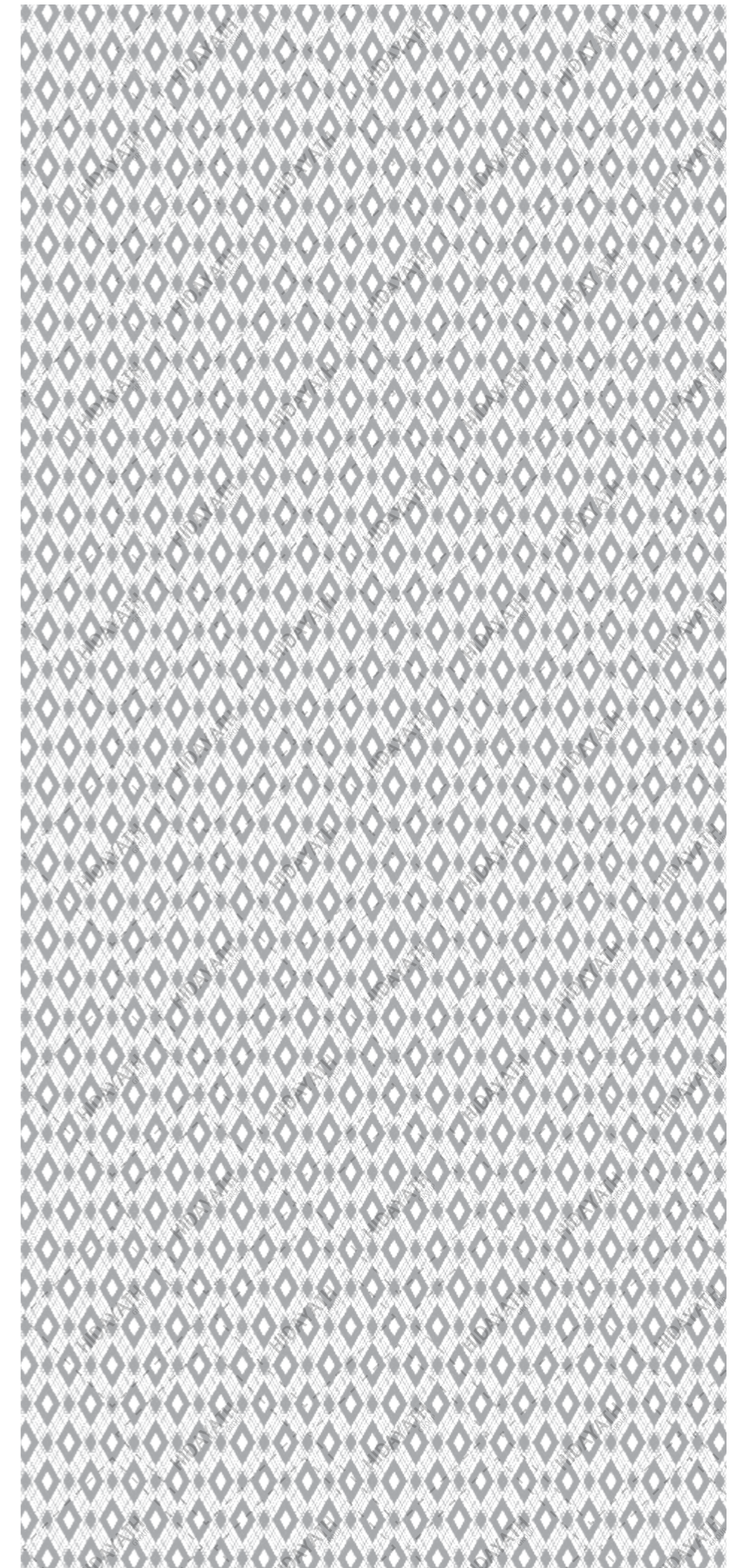
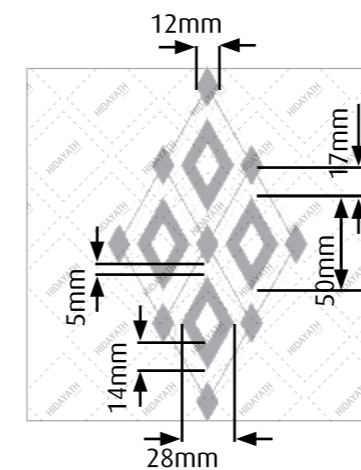

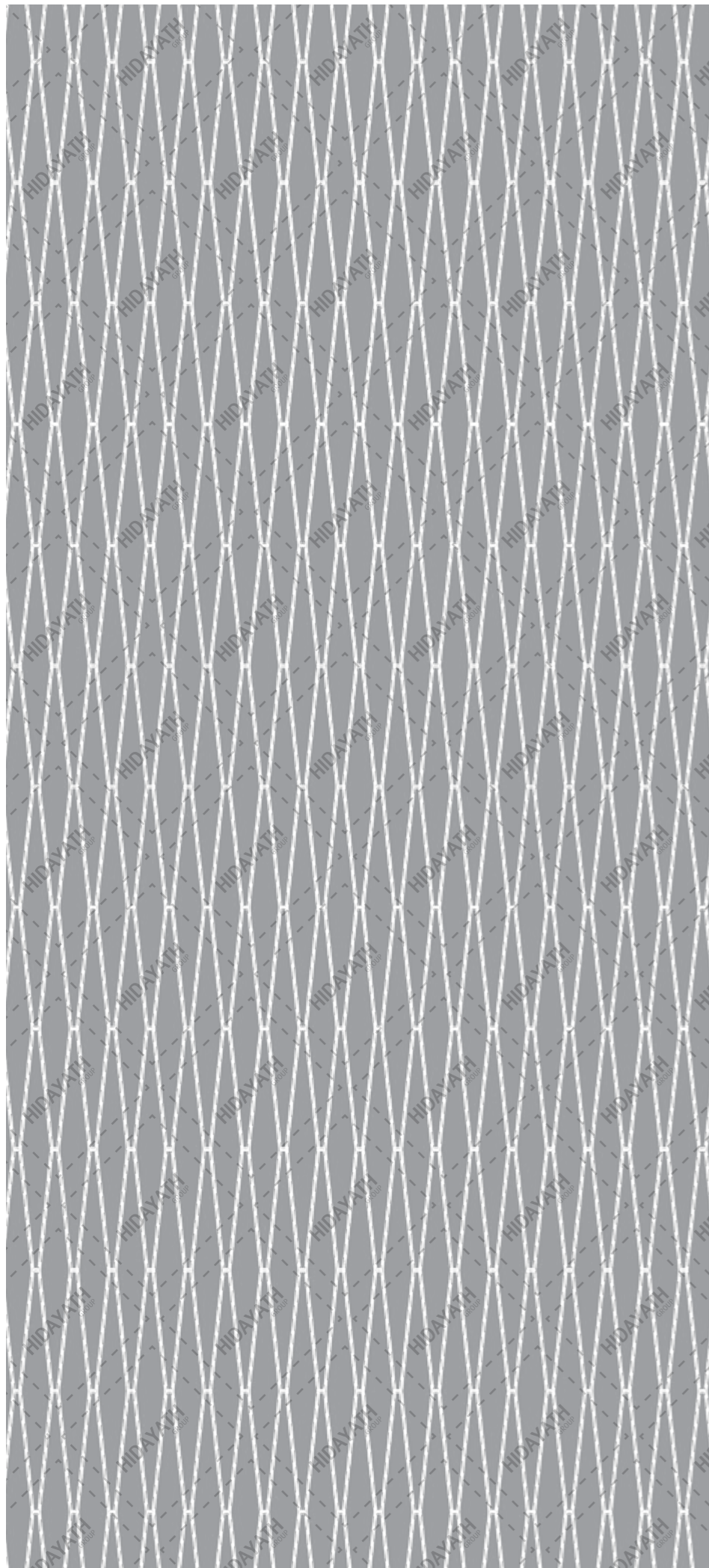

CODE
HTC 1022

Full sheet pattern orientation - **white** areas are etched.
Maximum Size: 8ft. x 4ft. (Etching)

Different finishes and colours are available on request.

Designs may be Waterjet cut or Laser cut as per requirement. Some designs may come with borders.

For detailed information kindly consult our sales personnel.

Note: The displayed illustration is for orientation only. Actual pattern may vary from the pattern shown.

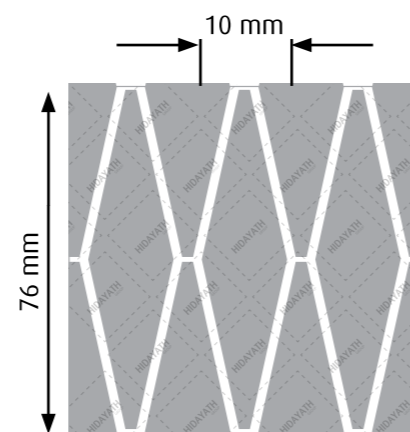

CODE
HTC 1023

Full sheet pattern orientation - **white** areas are etched.
Maximum Size: 8ft. x 4ft. (Etching)

Different finishes and colours are available on request.

Designs may be Waterjet cut or Laser cut as per requirement. Some designs may come with borders.

For detailed information kindly consult our sales personnel.

Note: The displayed illustration is for orientation only. Actual pattern may vary from the pattern shown.

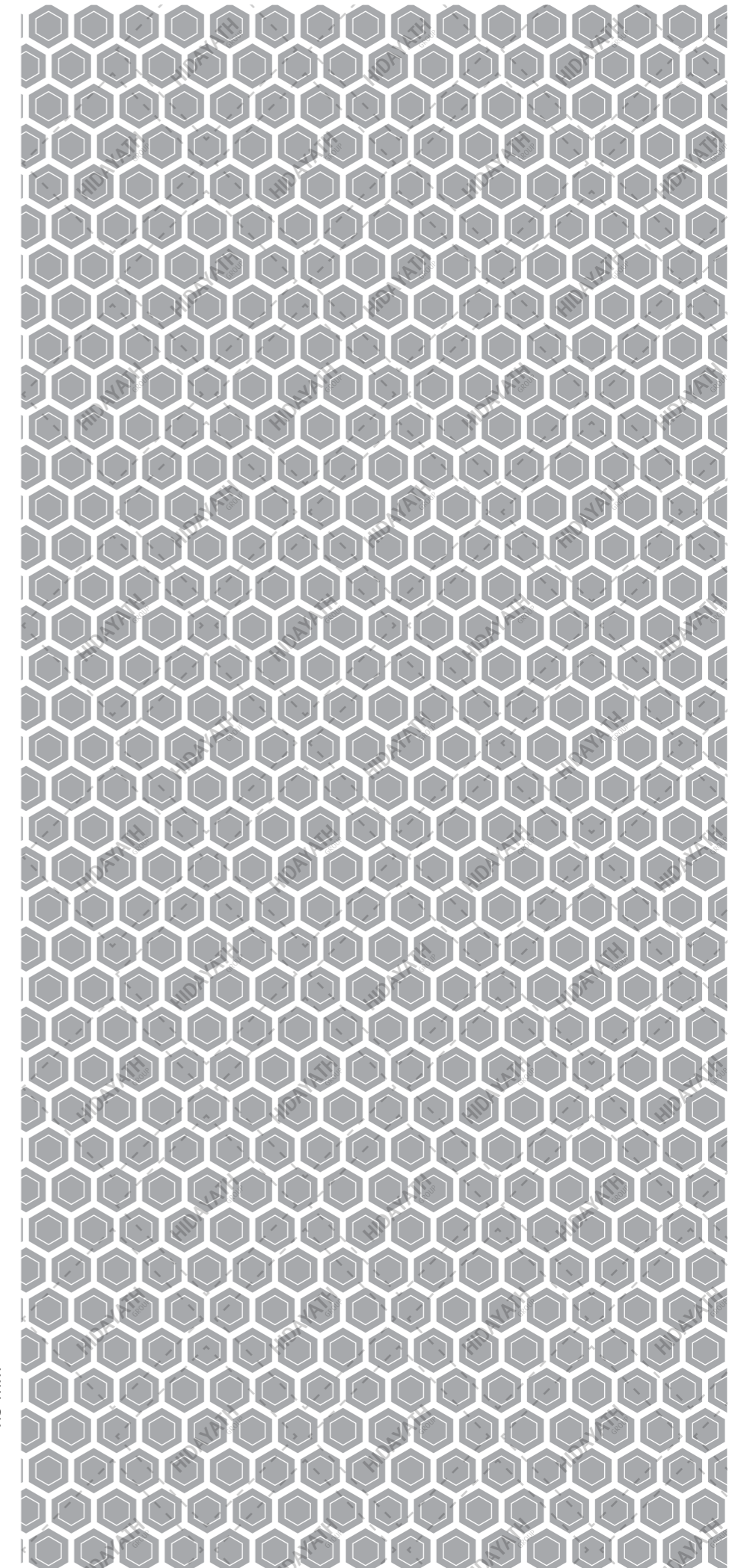
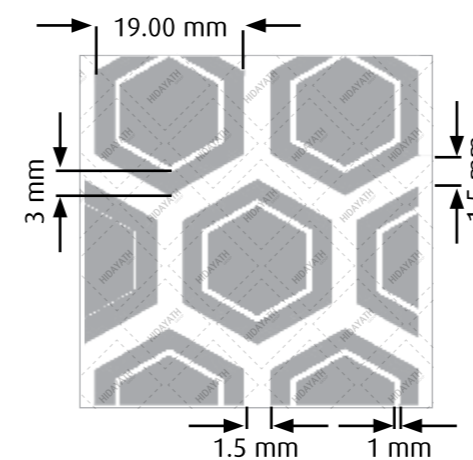

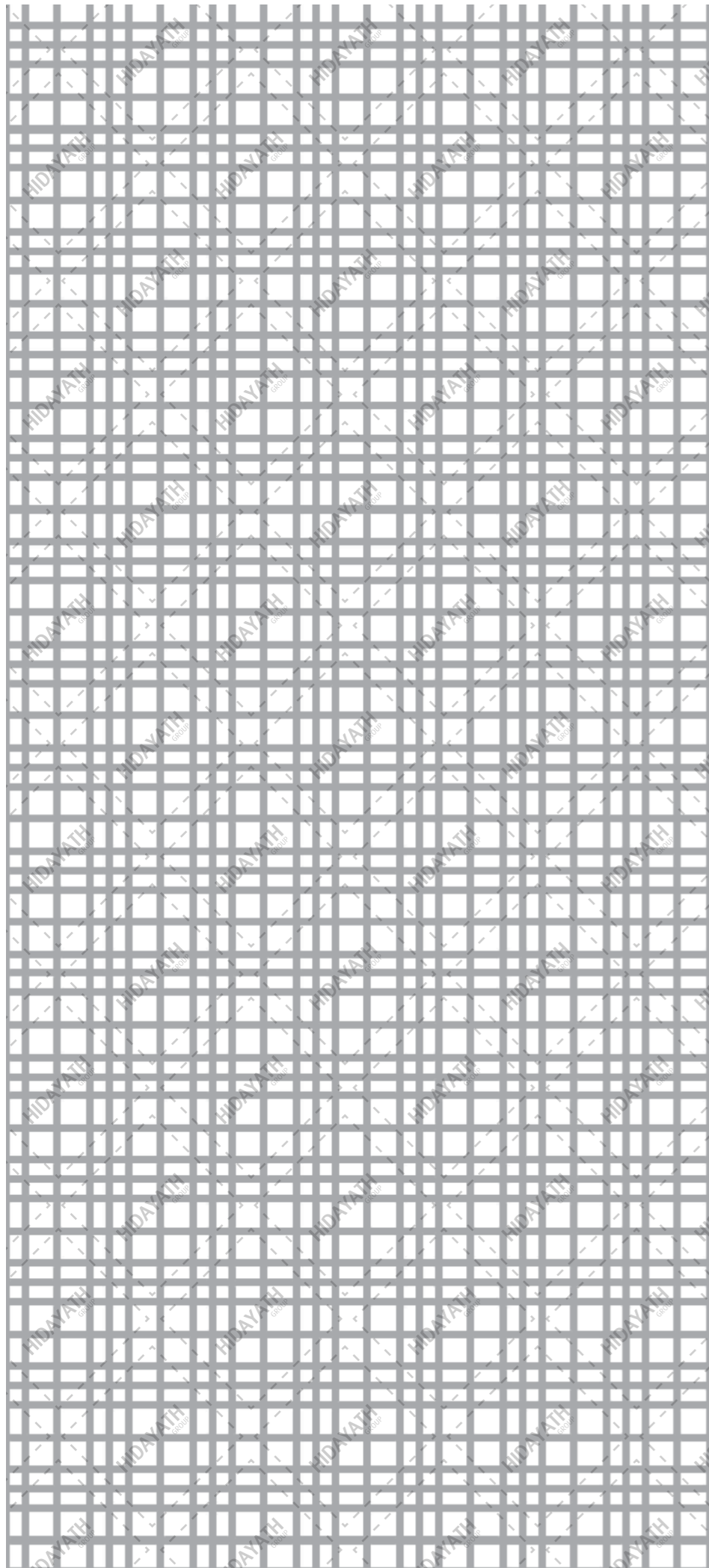

CODE
HTC 1024

Full sheet pattern orientation - **white** areas are etched.
Maximum Size: 8ft. x 4ft. (Etching)

Different finishes and colours are available on request.

Designs may be Waterjet cut or Laser cut as per requirement. Some designs may come with borders.

For detailed information kindly consult our sales personnel.

Note: The displayed illustration is for orientation only. Actual pattern may vary from the pattern shown.

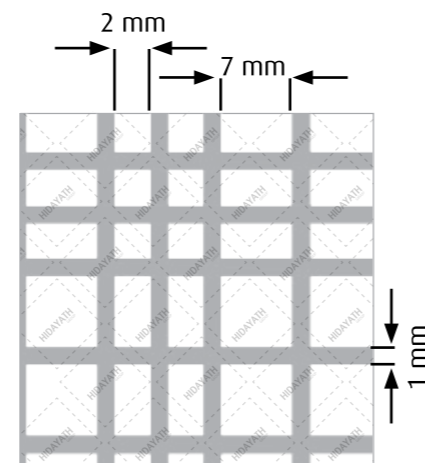

CODE
HTC 1025

Full sheet pattern orientation - **white** areas are etched.
Maximum Size: 8ft. x 4ft. (Etching)

Different finishes and colours are available on request.

Designs may be Waterjet cut or Laser cut as per requirement. Some designs may come with borders.

For detailed information kindly consult our sales personnel.

Note: The displayed illustration is for orientation only. Actual pattern may vary from the pattern shown.

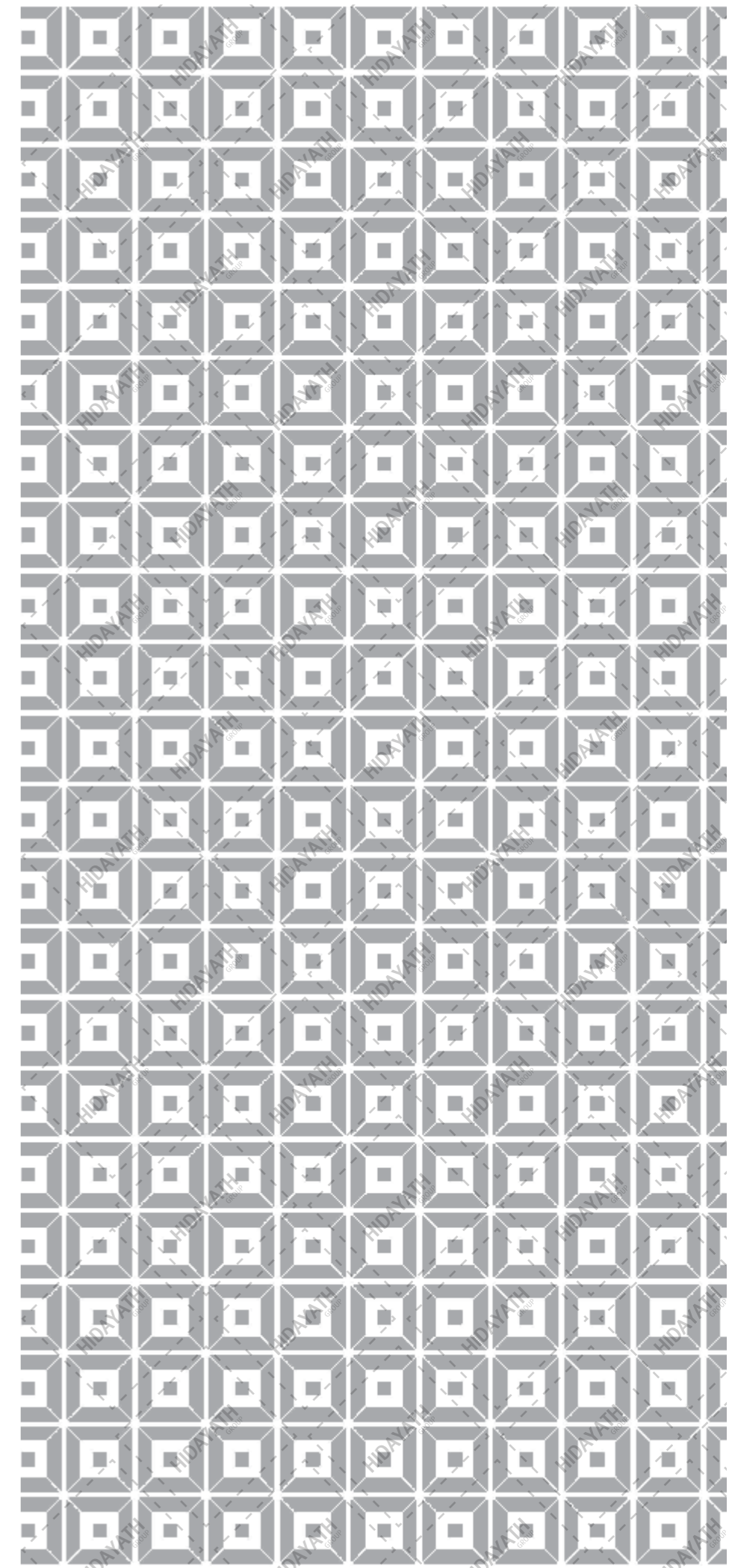
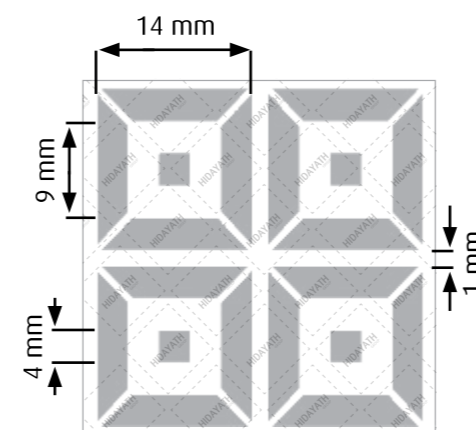

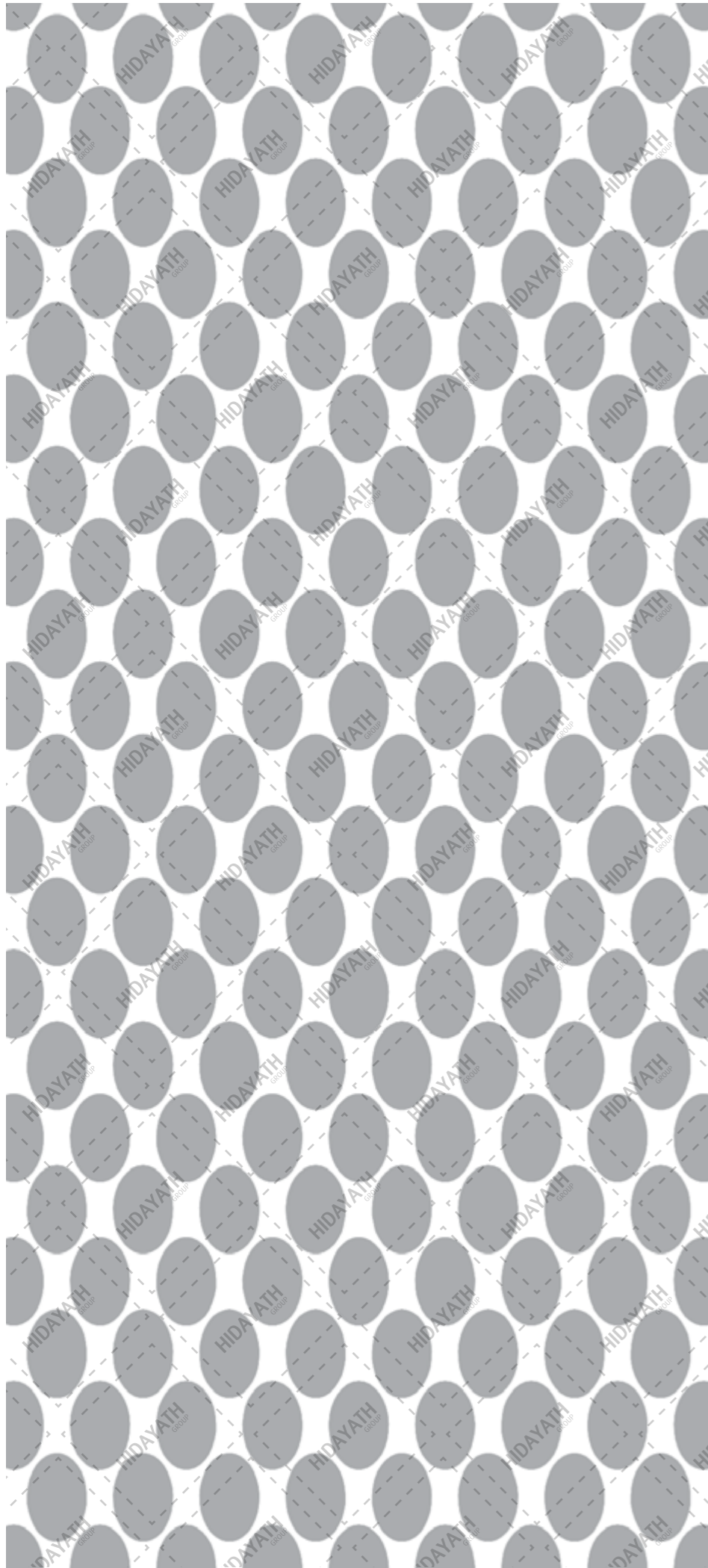

CODE
HTC 1026

Full sheet pattern orientation
white areas are etched.
Maximum Size: 8ft. x 4ft. (Etching)

Different finishes and colours are available on request.

Designs may be Waterjet cut or Laser cut as per requirement. Some designs may come with borders.

For detailed information kindly consult our sales personnel.

Note: The displayed illustration is for orientation only. Actual pattern may vary from the pattern shown.

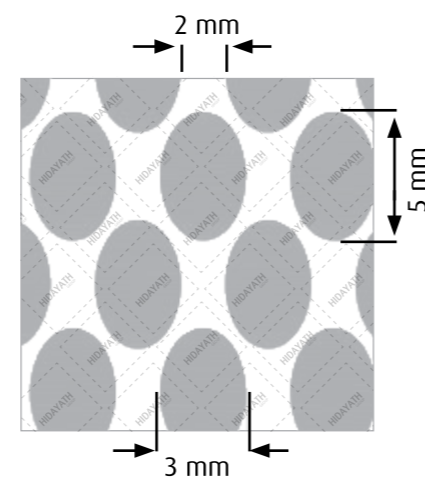

CODE
HTC 1027

Full sheet pattern orientation -
white areas are etched.
Maximum Size: 8ft. x 4ft. (Etching)

Different finishes and colours are available on request.

Designs may be Waterjet cut or Laser cut as per requirement. Some designs may come with borders.

For detailed information kindly consult our sales personnel.

Note: The displayed illustration is for orientation only. Actual pattern may vary from the pattern shown.

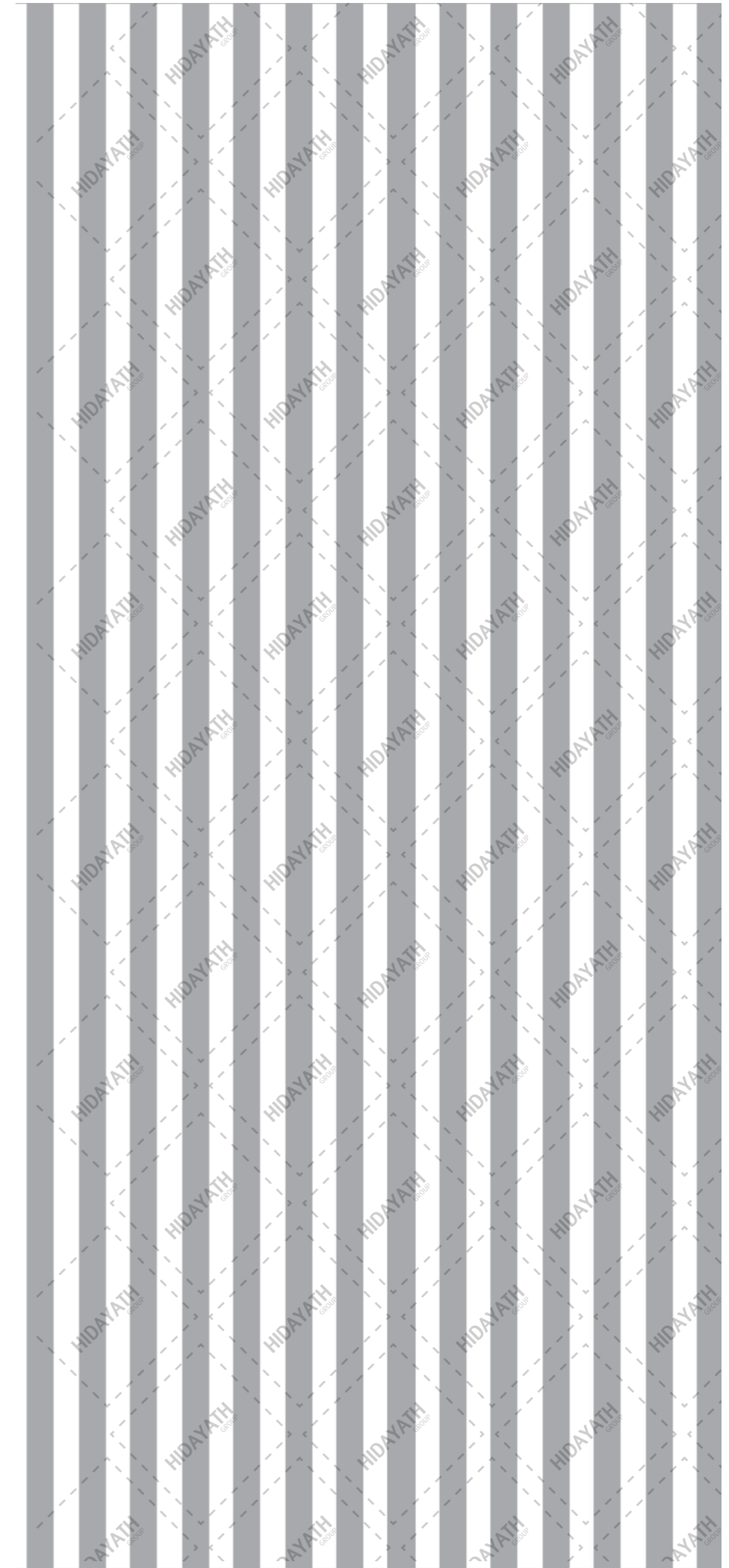
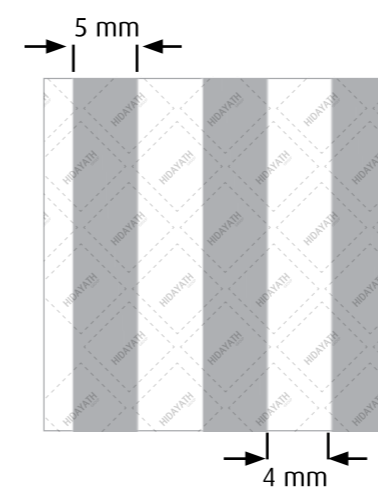

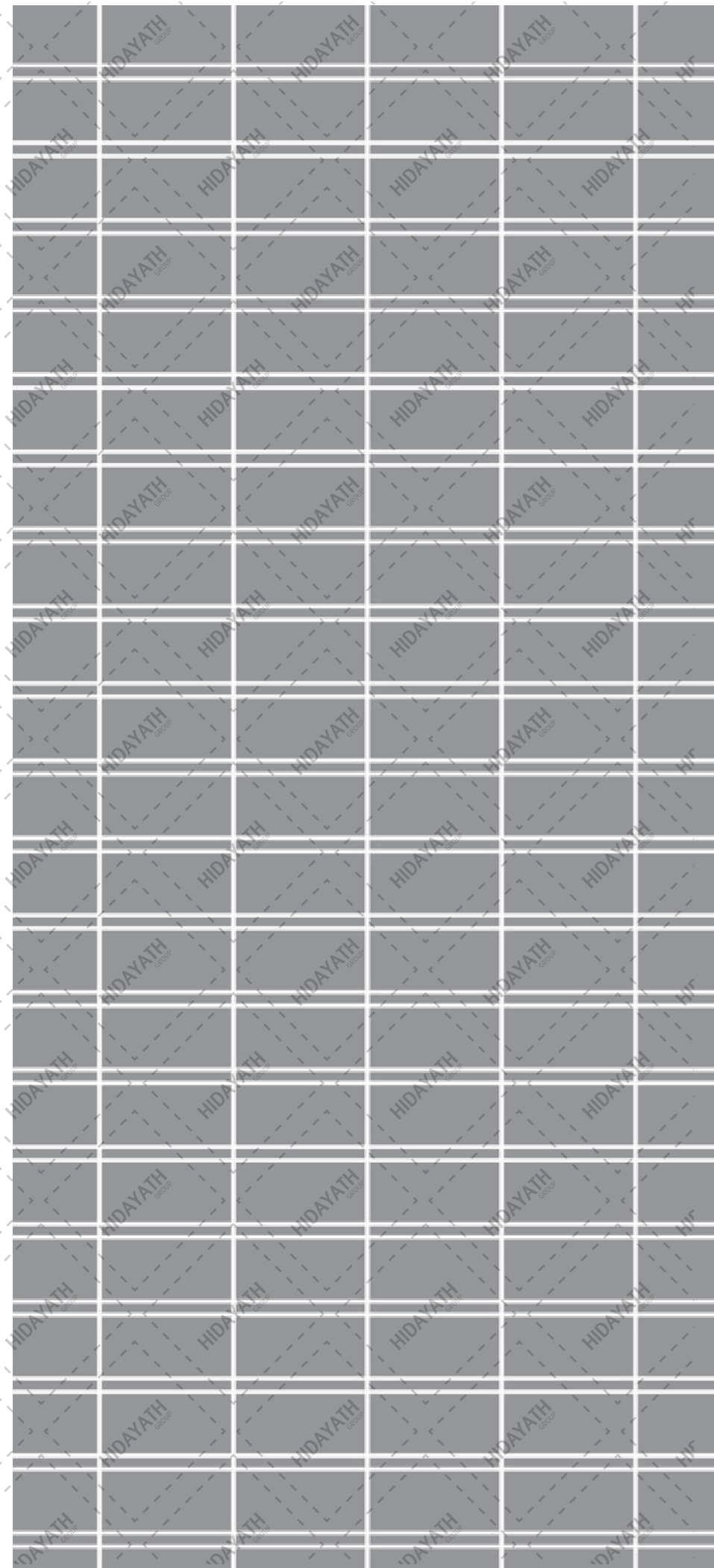

CODE
HTC 1029

Full sheet pattern orientation - **white** areas are etched.
Maximum Size: 8ft. x 4ft. (Etching)

Different finishes and colours are available on request.

Designs may be Waterjet cut or Laser cut as per requirement. Some designs may come with borders.

For detailed information kindly consult our sales personnel.

Note: The displayed illustration is for orientation only. Actual pattern may vary from the pattern shown.

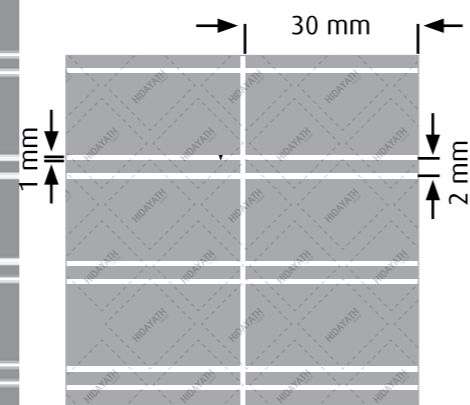

CODE
HTC 1030

Full sheet pattern orientation - **white** areas are etched.
Maximum Size: 8ft. x 4ft. (Etching)

Different finishes and colours are available on request.

Designs may be Waterjet cut or Laser cut as per requirement. Some designs may come with borders.

For detailed information kindly consult our sales personnel.

Note: The displayed illustration is for orientation only. Actual pattern may vary from the pattern shown.

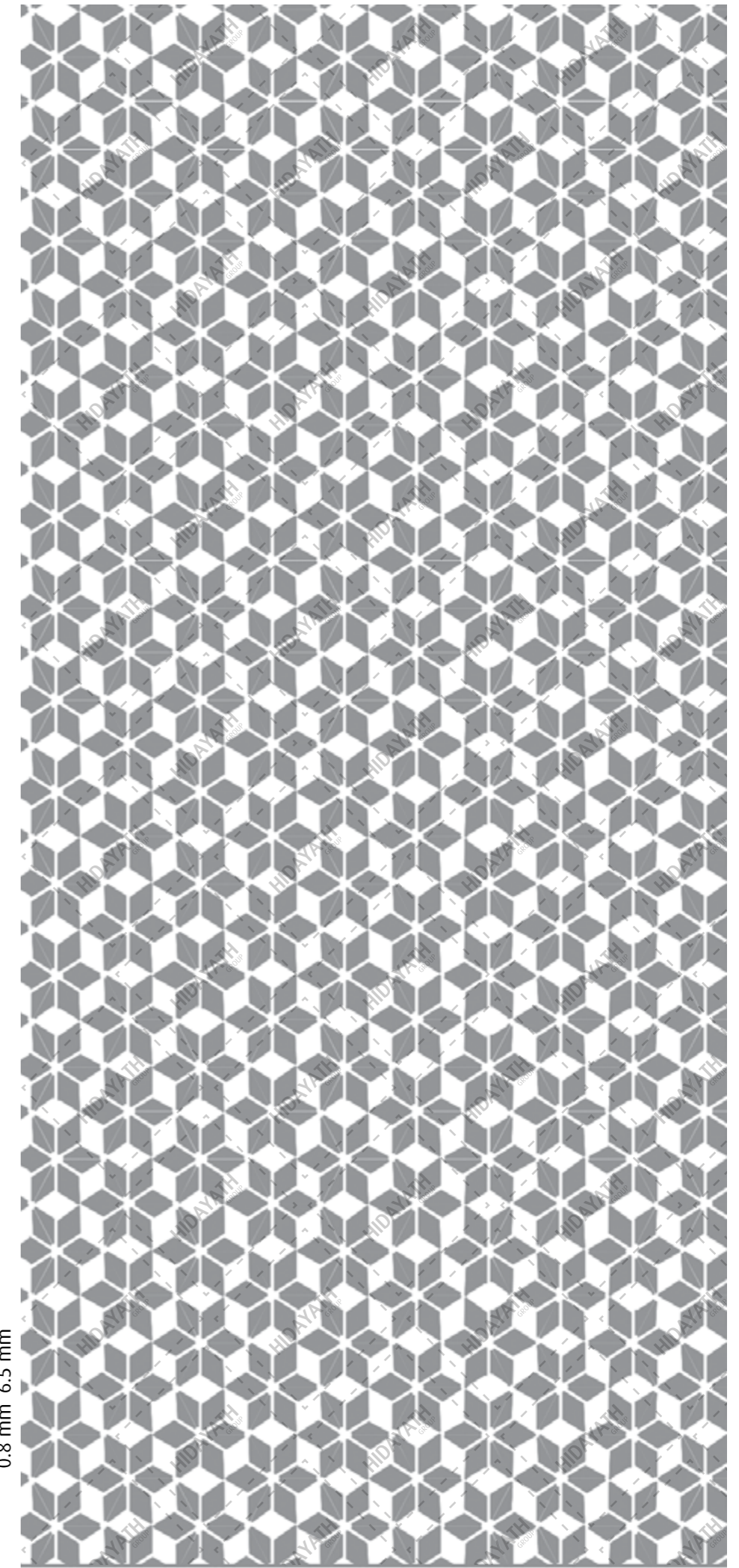
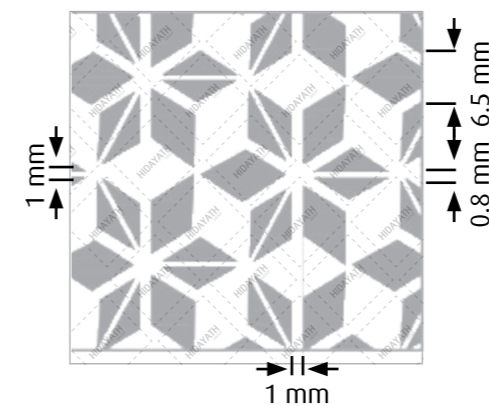

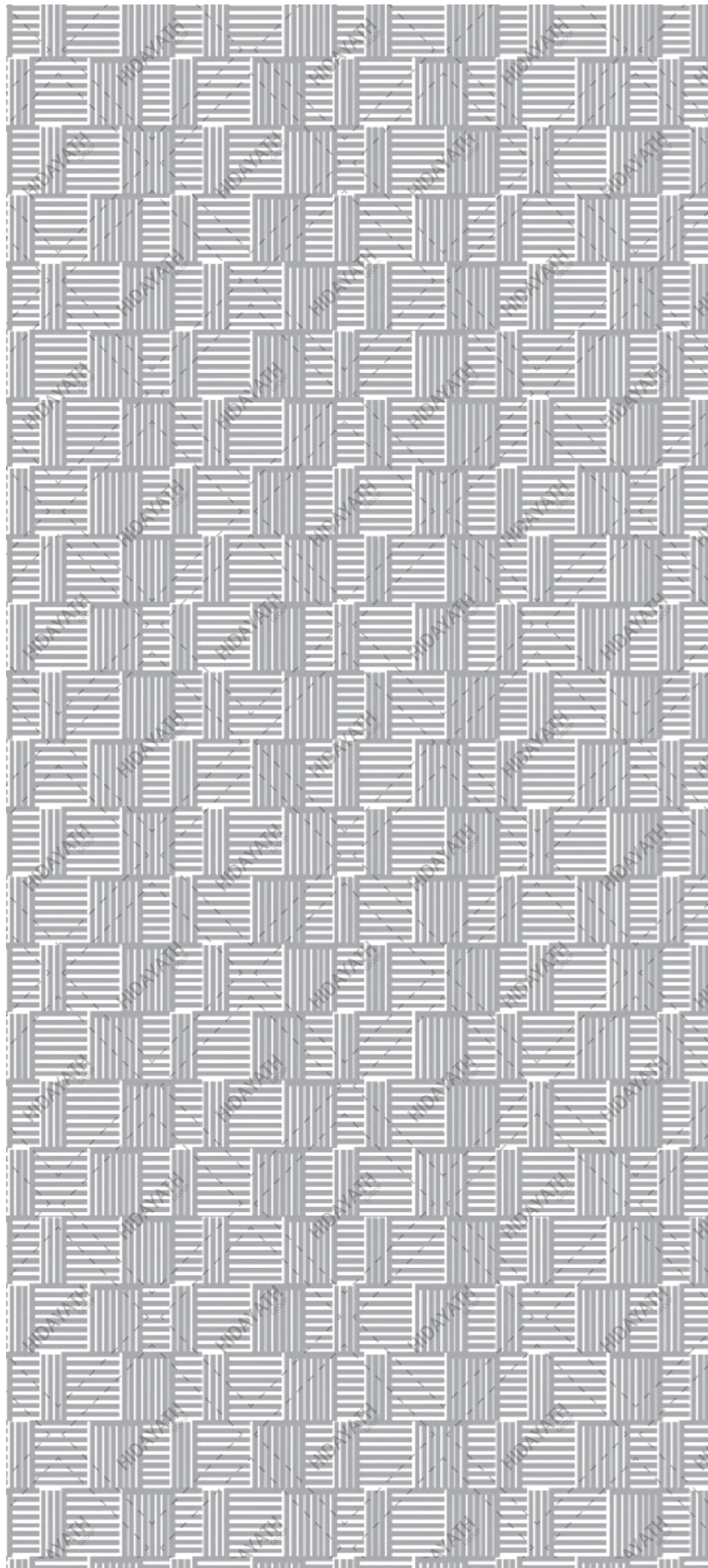

CODE
HTC 1032

Full sheet pattern orientation - **white** areas are etched.
Maximum Size: 8ft. x 4ft. (Etching)

Different finishes and colours are available on request.

Designs may be Waterjet cut or Laser cut as per requirement.
Some designs may come with borders.

For detailed information kindly consult our sales personnel.

Note: The displayed illustration is for orientation only. Actual pattern may vary from the pattern shown.

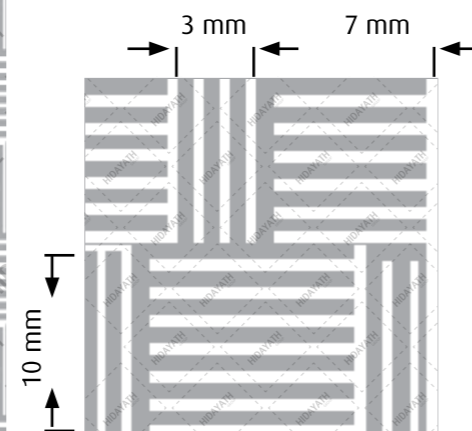

CODE
HTC 1033

Full sheet pattern orientation - **white** areas are etched.
Maximum Size: 8ft. x 4ft. (Etching)

Different finishes and colours are available on request.

Designs may be Waterjet cut or Laser cut as per requirement.
Some designs may come with borders.

For detailed information kindly consult our sales personnel.

Note: The displayed illustration is for orientation only. Actual pattern may vary from the pattern shown.

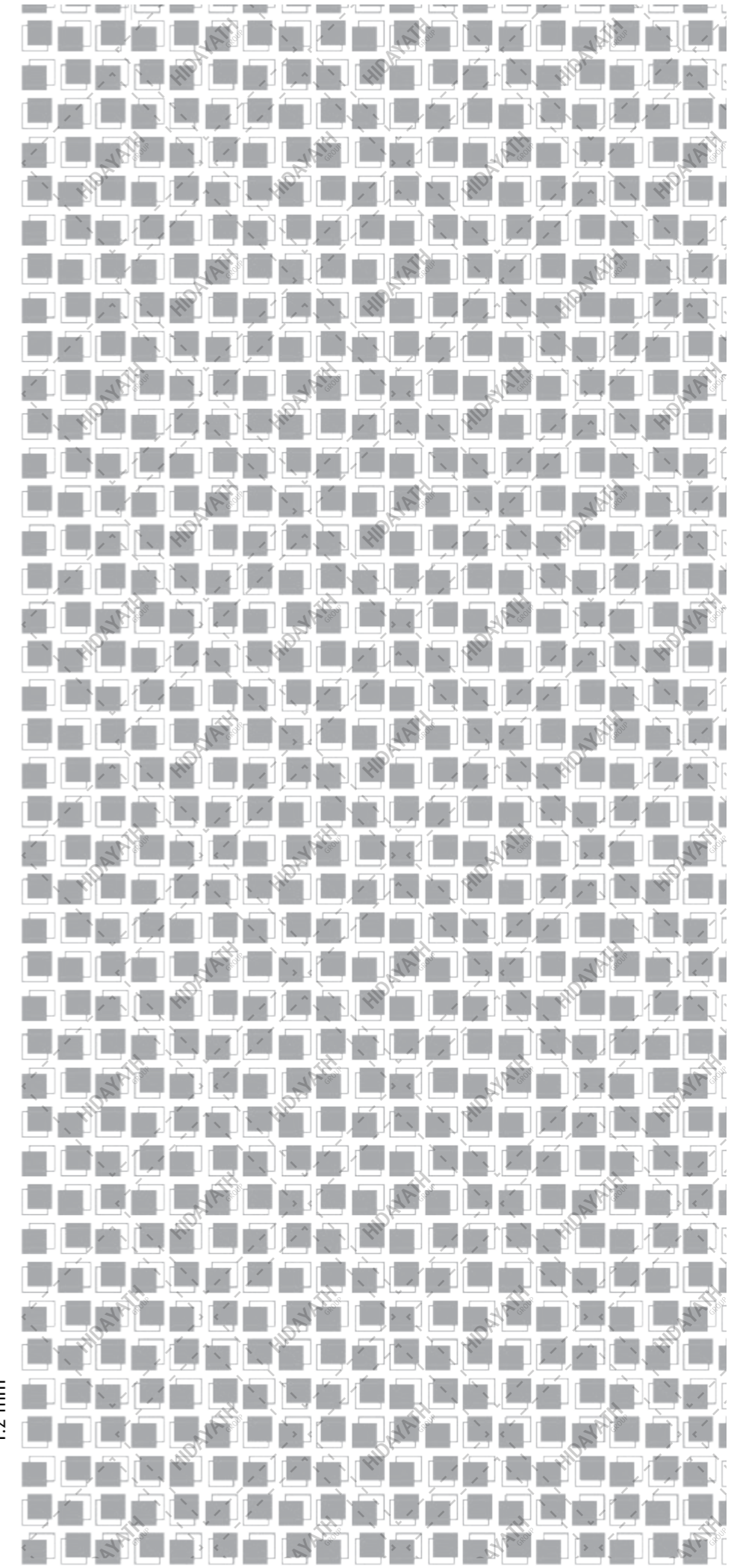
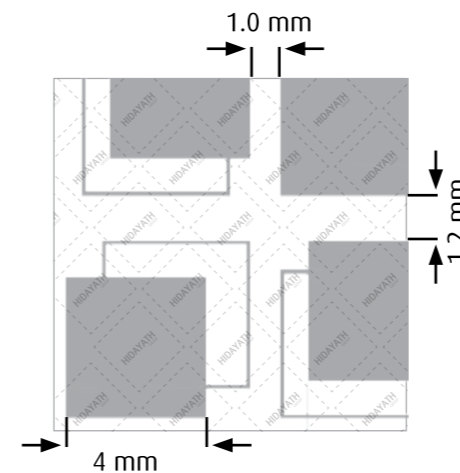



CODE
HTC 1041

Full sheet pattern orientation - **white** areas are etched.
Maximum Size: 8ft. x 4ft. (Etching)

Different finishes and colours are available on request.

Designs may be Waterjet cut or Laser cut as per requirement. Some designs may come with borders.

For detailed information kindly consult our sales personnel.

Note: The displayed illustration is for orientation only. Actual pattern may vary from the pattern shown.

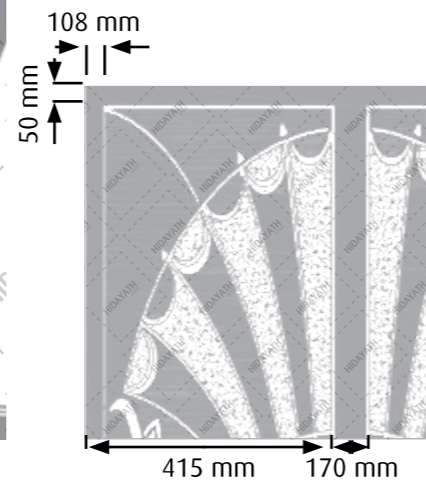

CODE
HTC 1042

Full sheet pattern orientation - **white** areas are etched.
Maximum Size: 8ft. x 4ft. (Etching)

Different finishes and colours are available on request.

Designs may be Waterjet cut or Laser cut as per requirement. Some designs may come with borders.

For detailed information kindly consult our sales personnel.

Note: The displayed illustration is for orientation only. Actual pattern may vary from the pattern shown.

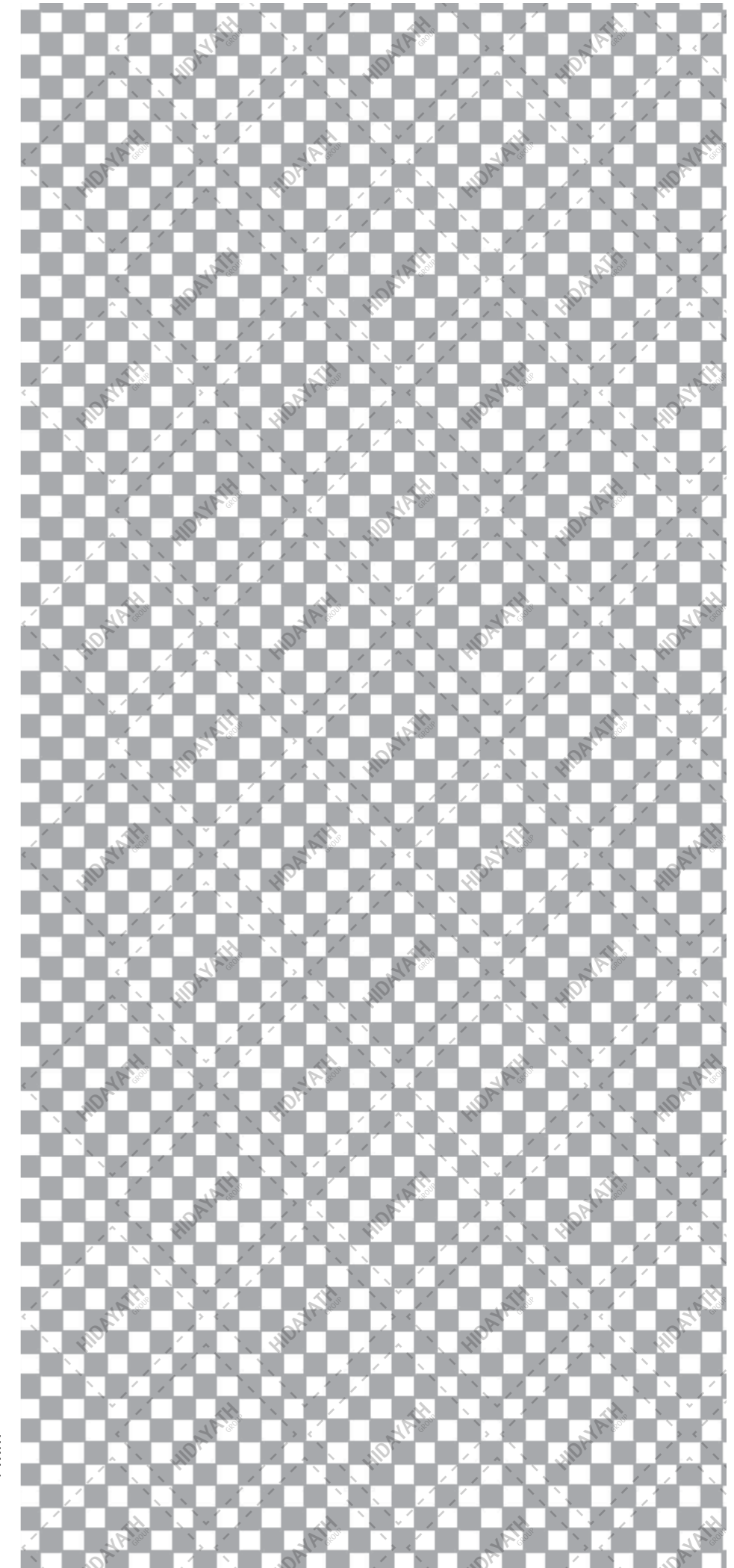
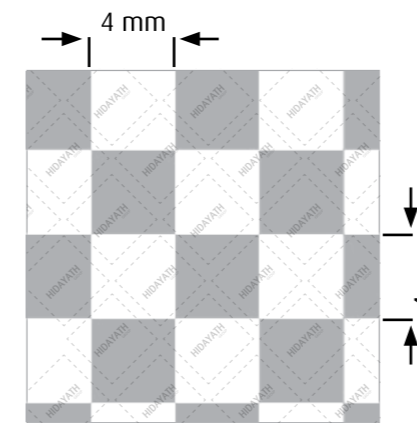

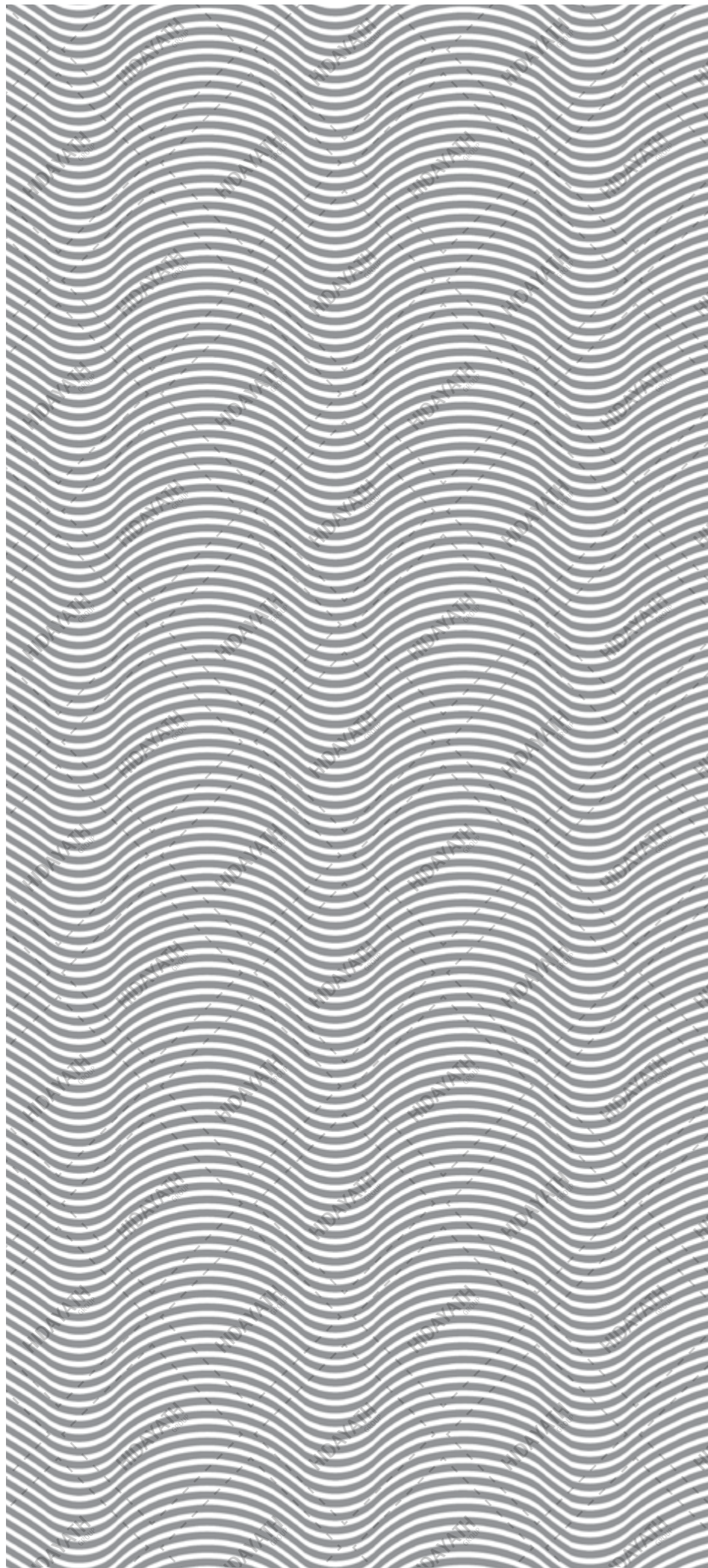

CODE
HTC 1043

Full sheet pattern orientation - **white** areas are etched.
Maximum Size: 8ft. x 4ft. (Etching)

Different finishes and colours are available on request.

Designs may be Waterjet cut or Laser cut as per requirement. Some designs may come with borders.

For detailed information kindly consult our sales personnel.

Note: The displayed illustration is for orientation only. Actual pattern may vary from the pattern shown.

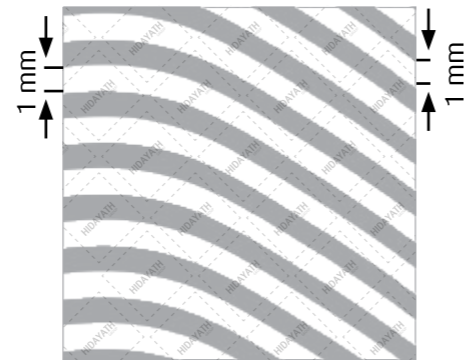

CODE
HTC 1044

Full sheet pattern orientation - **white** areas are etched.
Maximum Size: 8ft. x 4ft. (Etching)

Different finishes and colours are available on request.

Designs may be Waterjet cut or Laser cut as per requirement. Some designs may come with borders.

For detailed information kindly consult our sales personnel.

Note: The displayed illustration is for orientation only. Actual pattern may vary from the pattern shown.

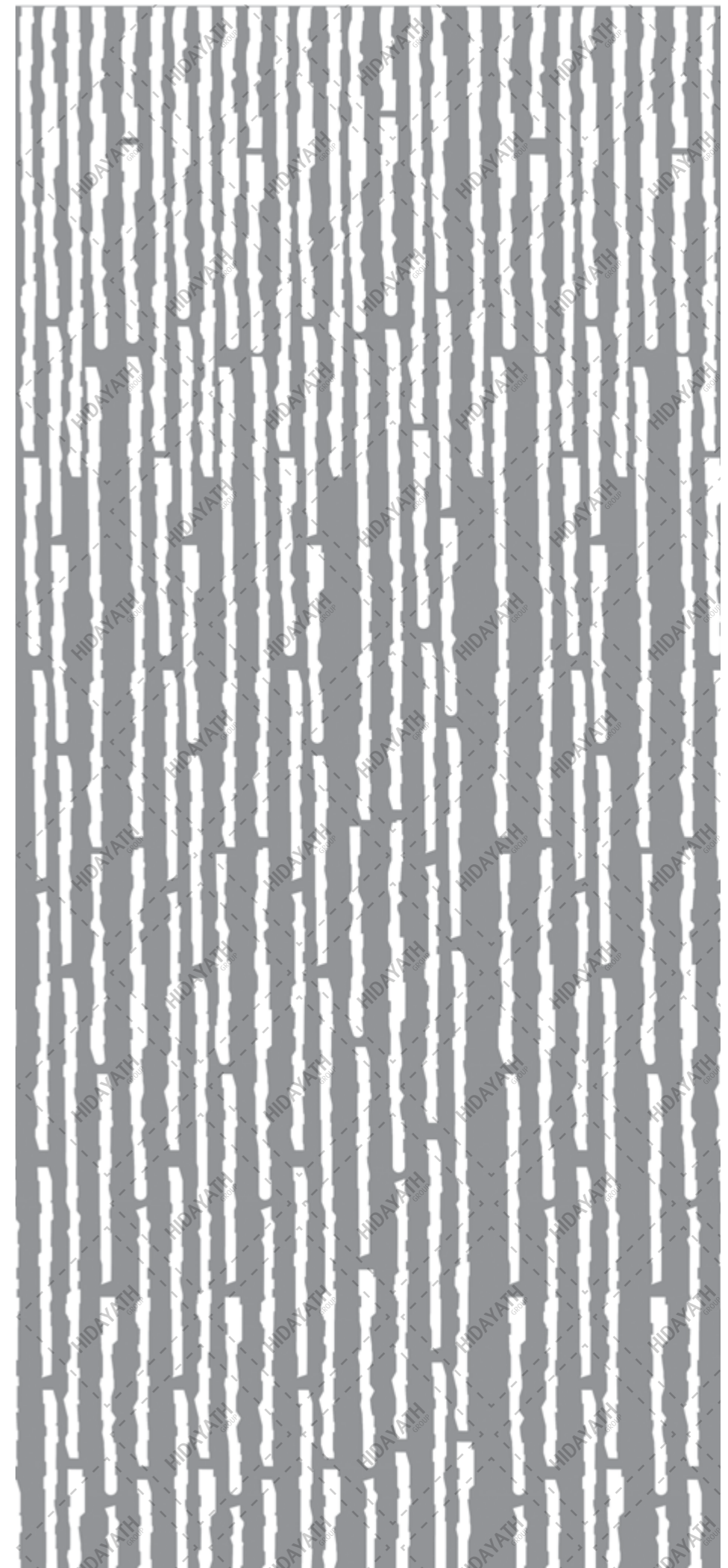
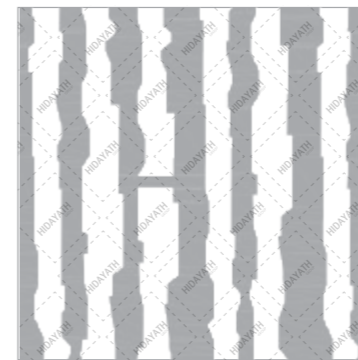

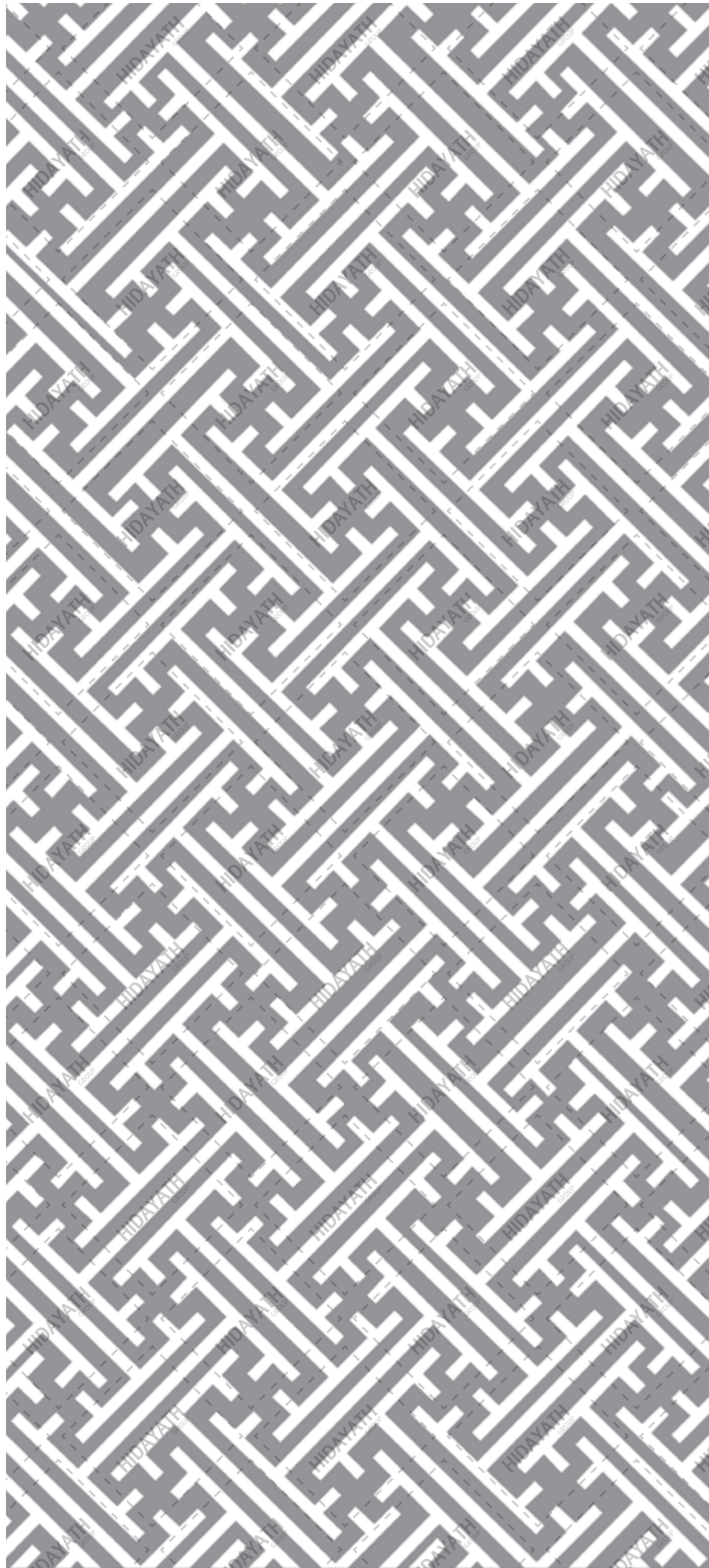

CODE
HTC 1045

Full sheet pattern orientation - **white** areas are etched.
Maximum Size: 8ft. x 4ft. (Etching)

Different finishes and colours are available on request.

Designs may be Waterjet cut or Laser cut as per requirement. Some designs may come with borders.

For detailed information kindly consult our sales personnel.

Note: The displayed illustration is for orientation only. Actual pattern may vary from the pattern shown.

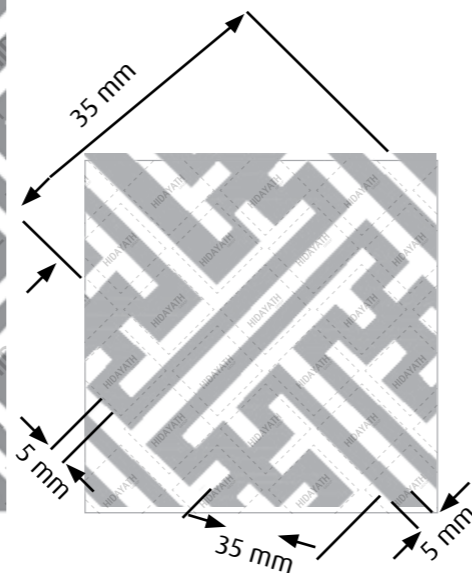

CODE
HTC 1046

Full sheet pattern orientation - **white** areas are etched.
Maximum Size: 8ft. x 4ft. (Etching)

Different finishes and colours are available on request.

Designs may be Waterjet cut or Laser cut as per requirement. Some designs may come with borders.

For detailed information kindly consult our sales personnel.

Note: The displayed illustration is for orientation only. Actual pattern may vary from the pattern shown.

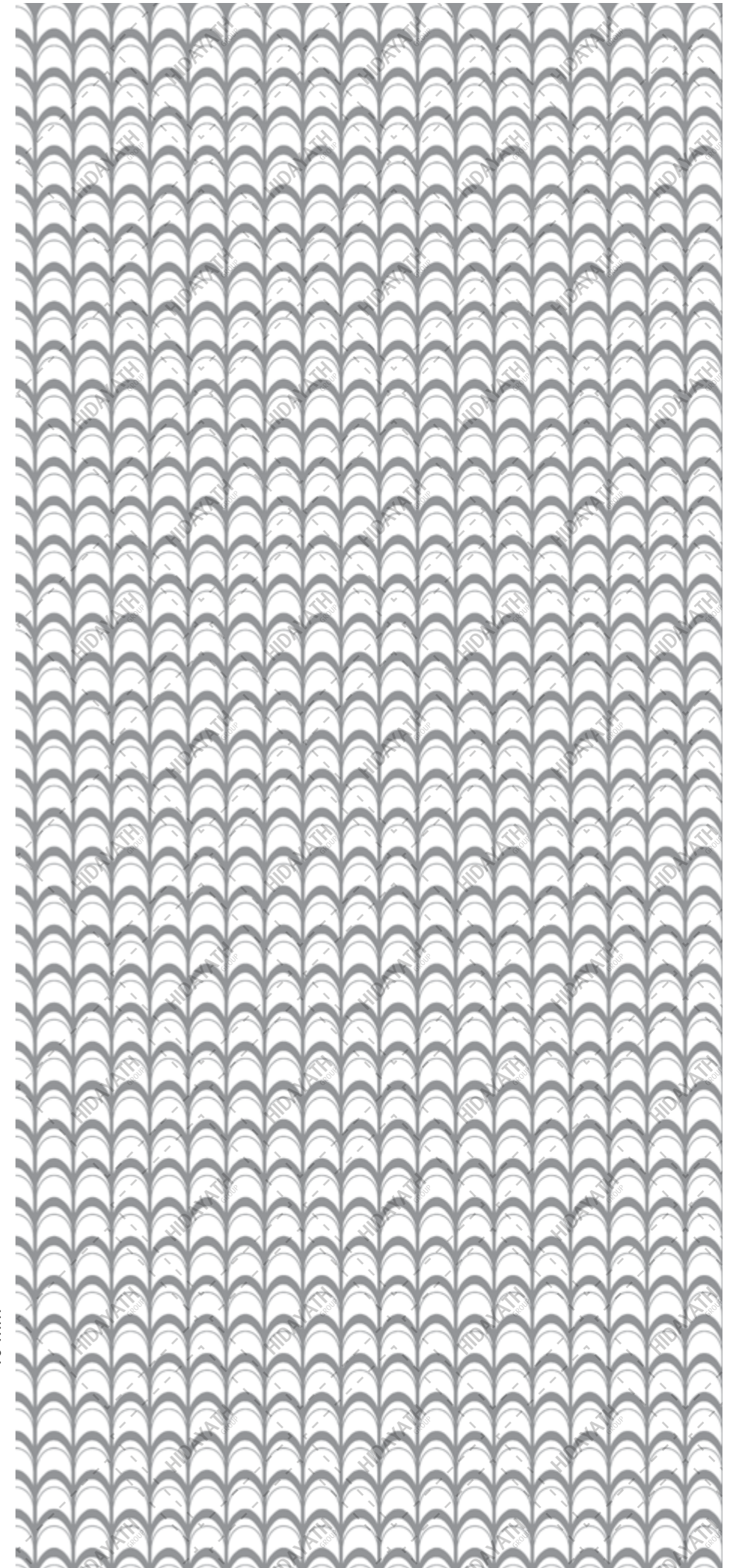
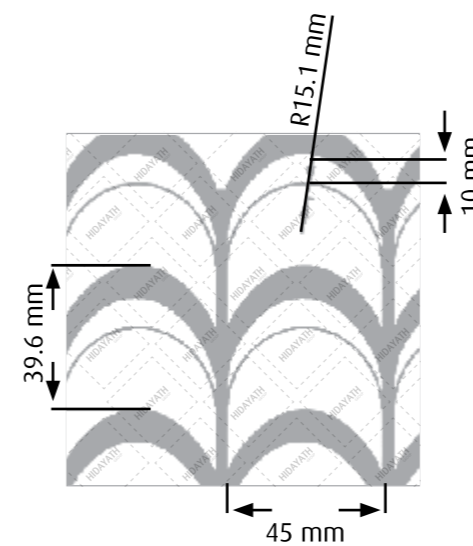

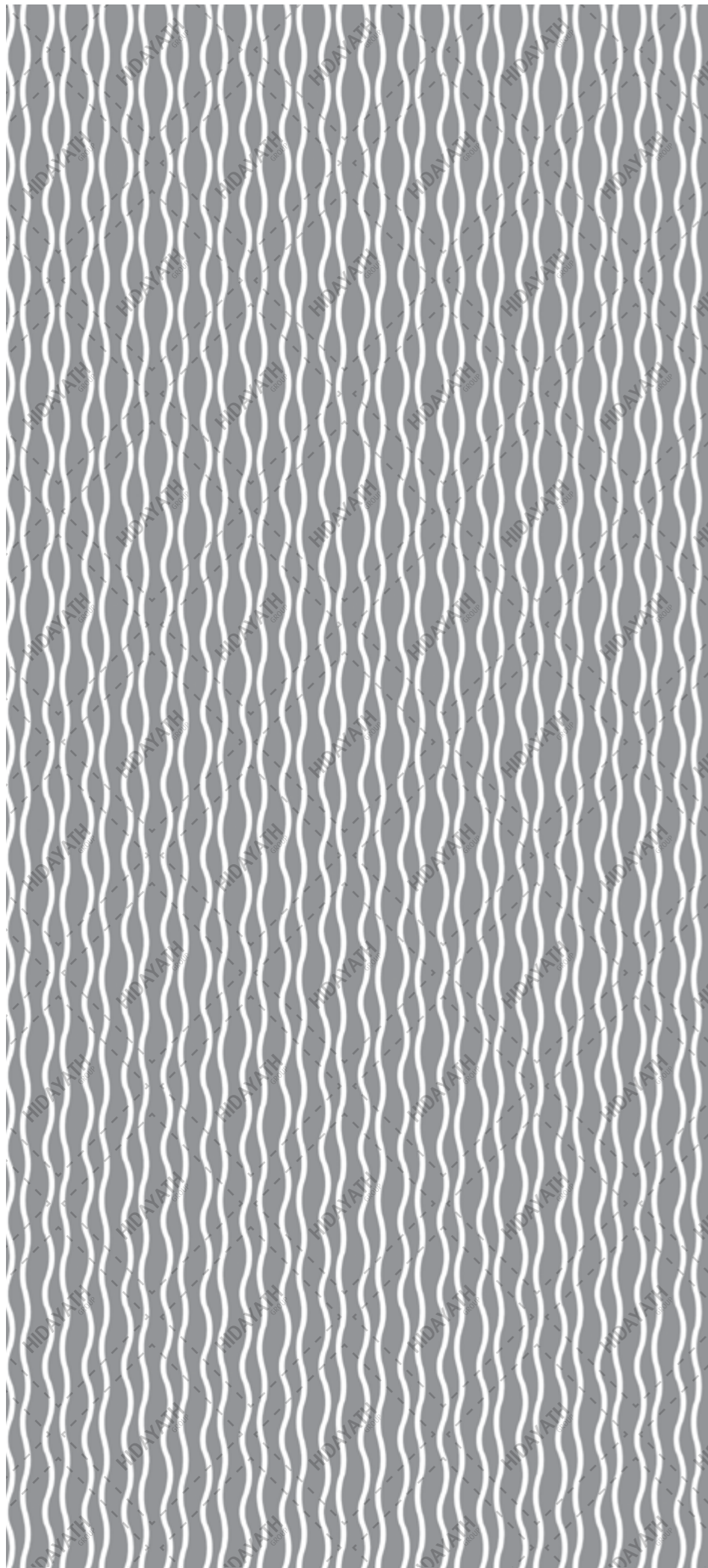

CODE
HTC 1047

Full sheet pattern orientation - **white** areas are etched.
Maximum Size: 8ft. x 4ft. (Etching)

Different finishes and colours are available on request.

Designs may be Waterjet cut or Laser cut as per requirement. Some designs may come with borders.

For detailed information kindly consult our sales personnel.

Note: The displayed illustration is for orientation only. Actual pattern may vary from the pattern shown.

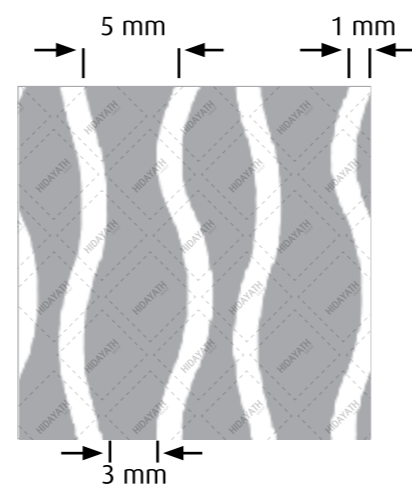

CODE
HTC 1048

Full sheet pattern orientation - **white** areas are etched.
Maximum Size: 8ft. x 4ft. (Etching)

Different finishes and colours are available on request.

Designs may be Waterjet cut or Laser cut as per requirement. Some designs may come with borders.

For detailed information kindly consult our sales personnel.

Note: The displayed illustration is for orientation only. Actual pattern may vary from the pattern shown.

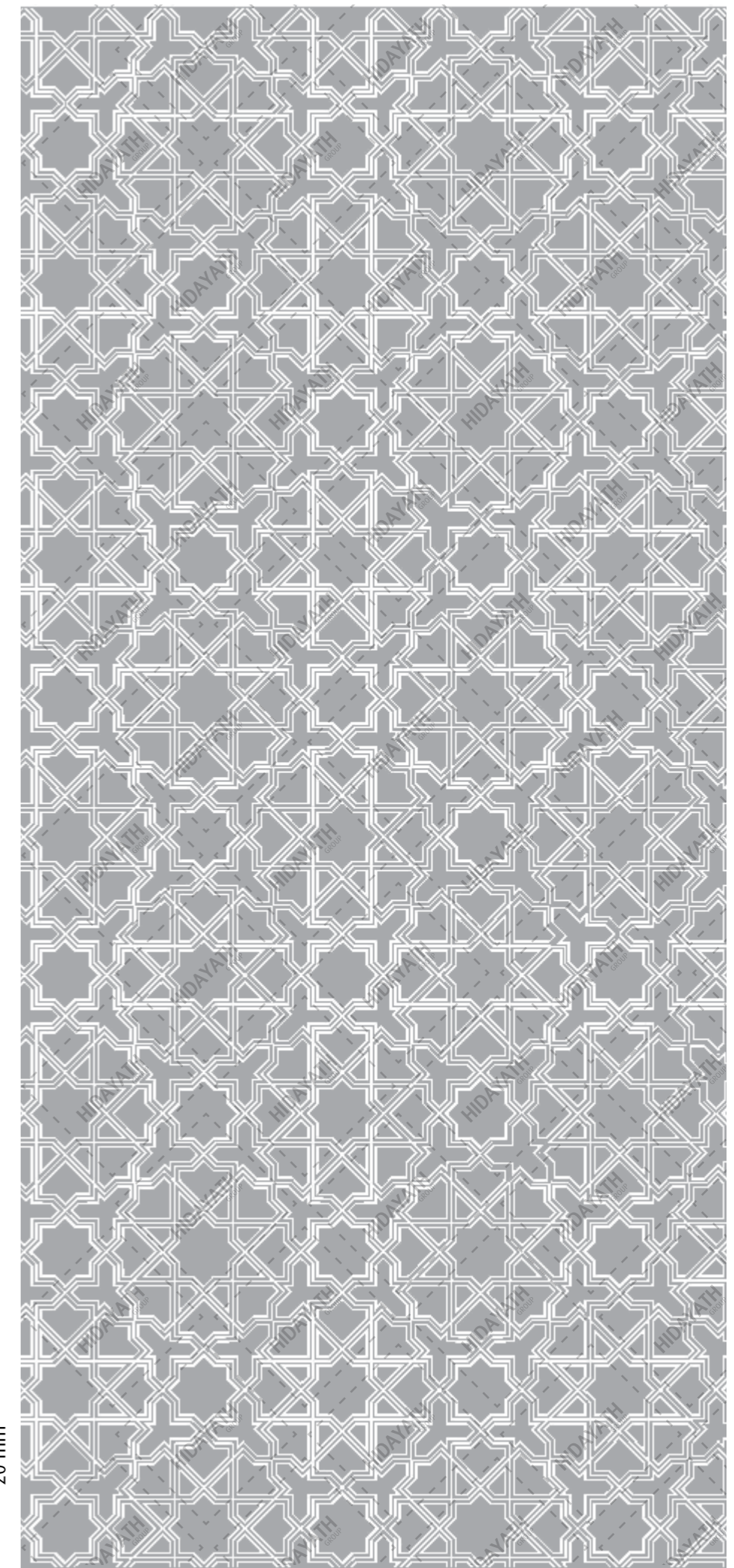
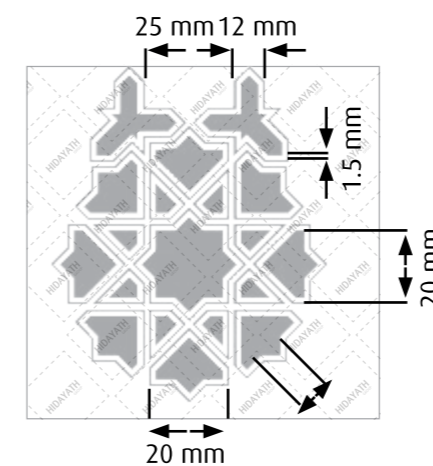

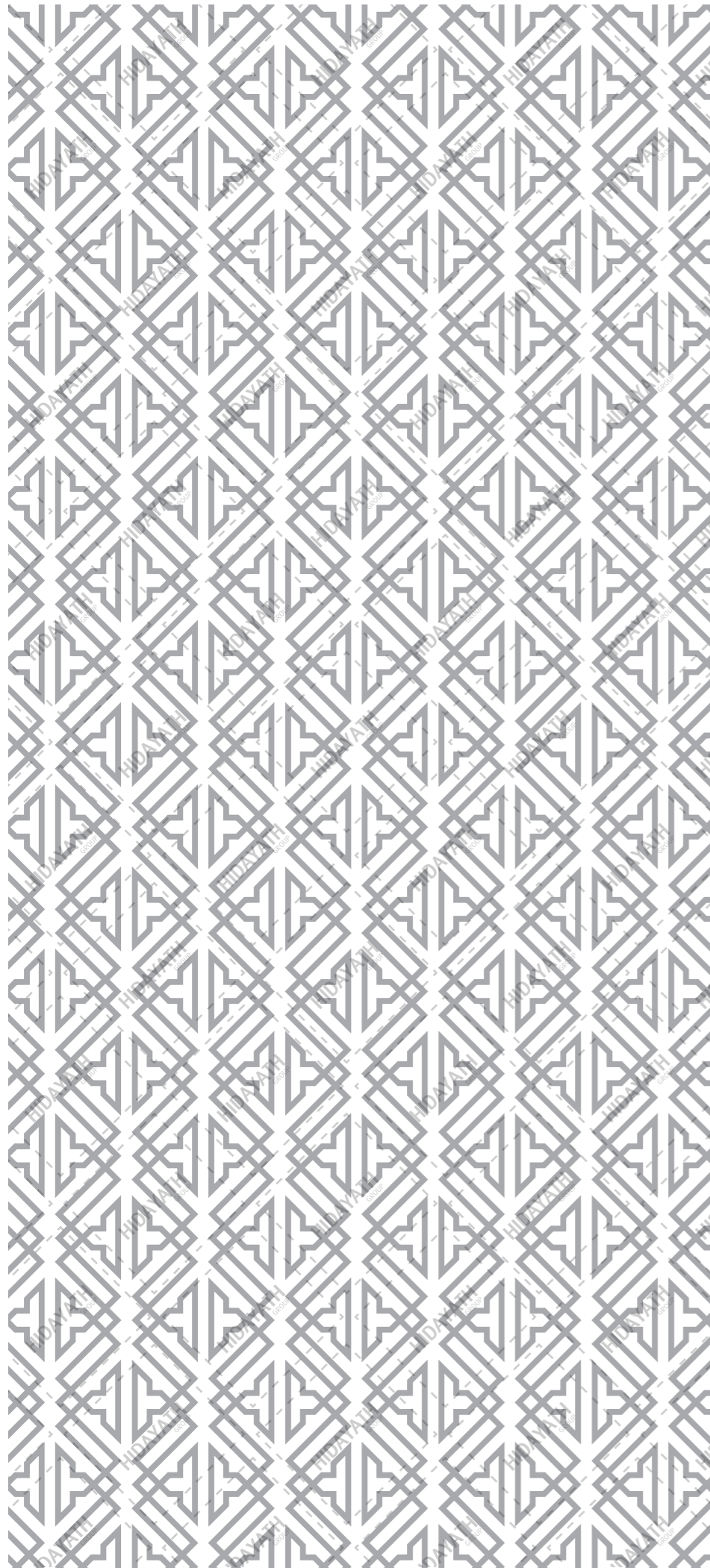

CODE
HTC 1050

Full sheet pattern orientation - **white** areas are etched.
Maximum Size: 8ft. x 4ft. (Etching)

Different finishes and colours are available on request.

Designs may be Waterjet cut or Laser cut as per requirement. Some designs may come with borders.

For detailed information kindly consult our sales personnel.

Note: The displayed illustration is for orientation only. Actual pattern may vary from the pattern shown.

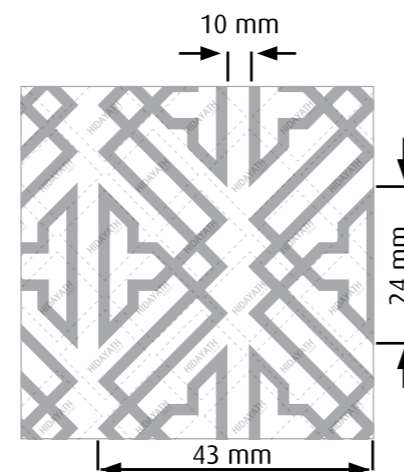

CODE
HTC 1051

Full sheet pattern orientation - **white** areas are etched.
Maximum Size: 8ft. x 4ft. (Etching)

Different finishes and colours are available on request.

Designs may be Waterjet cut or Laser cut as per requirement. Some designs may come with borders.

For detailed information kindly consult our sales personnel.

Note: The displayed illustration is for orientation only. Actual pattern may vary from the pattern shown.



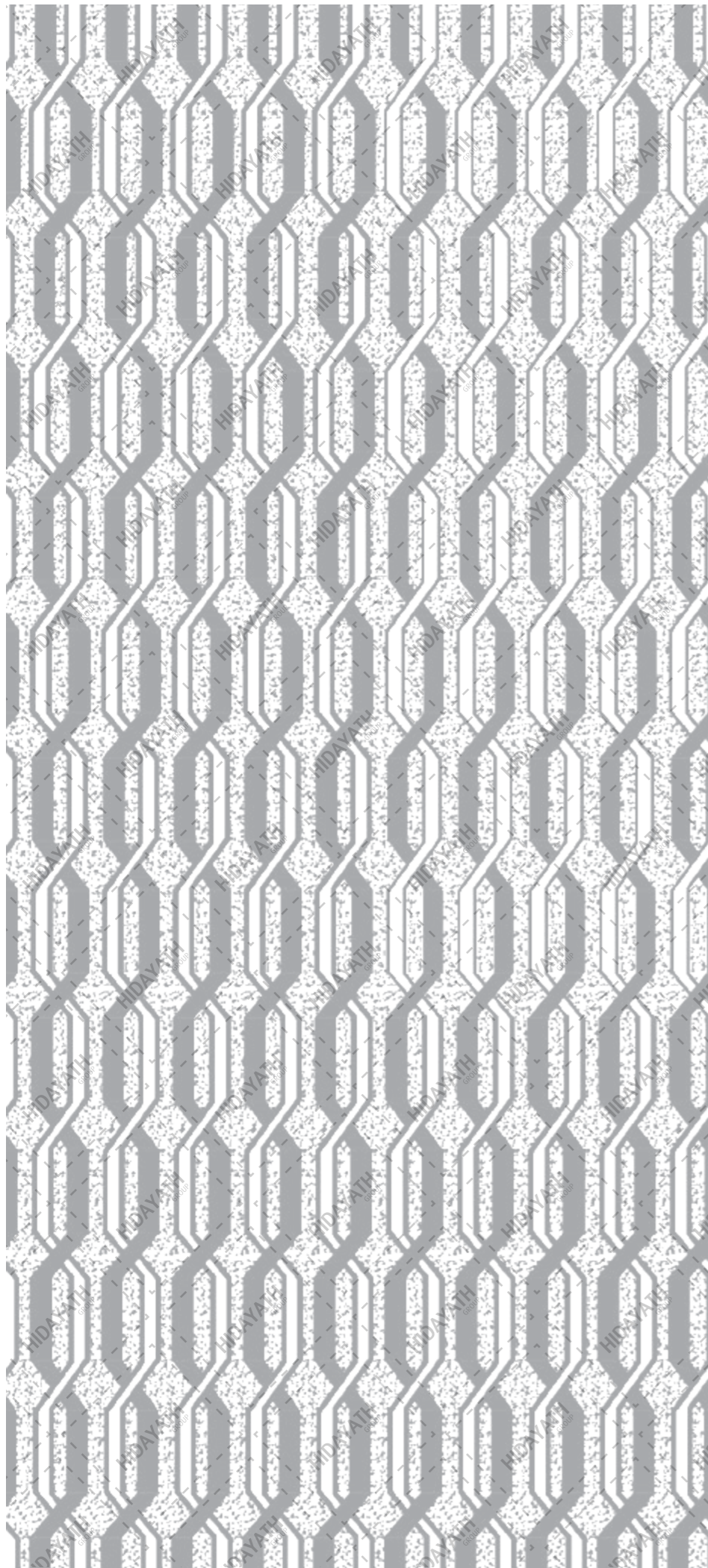

CODE
HTC 1052

Full sheet pattern orientation
white areas are etched.
Maximum Size: 8ft. x 4ft. (Etching)

Different finishes and colours are available on request.

Designs may be Waterjet cut or Laser cut as per requirement. Some designs may come with borders.

For detailed information kindly consult our sales personnel.

Note: The displayed illustration is for orientation only. Actual pattern may vary from the pattern shown.

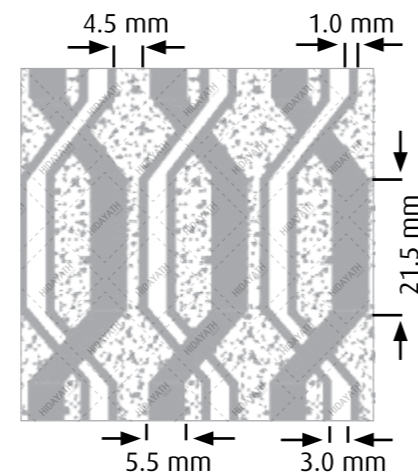

CODE
HTC 1053

Full sheet pattern orientation -
white areas are etched.
Maximum Size: 8ft. x 4ft. (Etching)

Different finishes and colours are available on request.

Designs may be Waterjet cut or Laser cut as per requirement. Some designs may come with borders.

For detailed information kindly consult our sales personnel.

Note: The displayed illustration is for orientation only. Actual pattern may vary from the pattern shown.

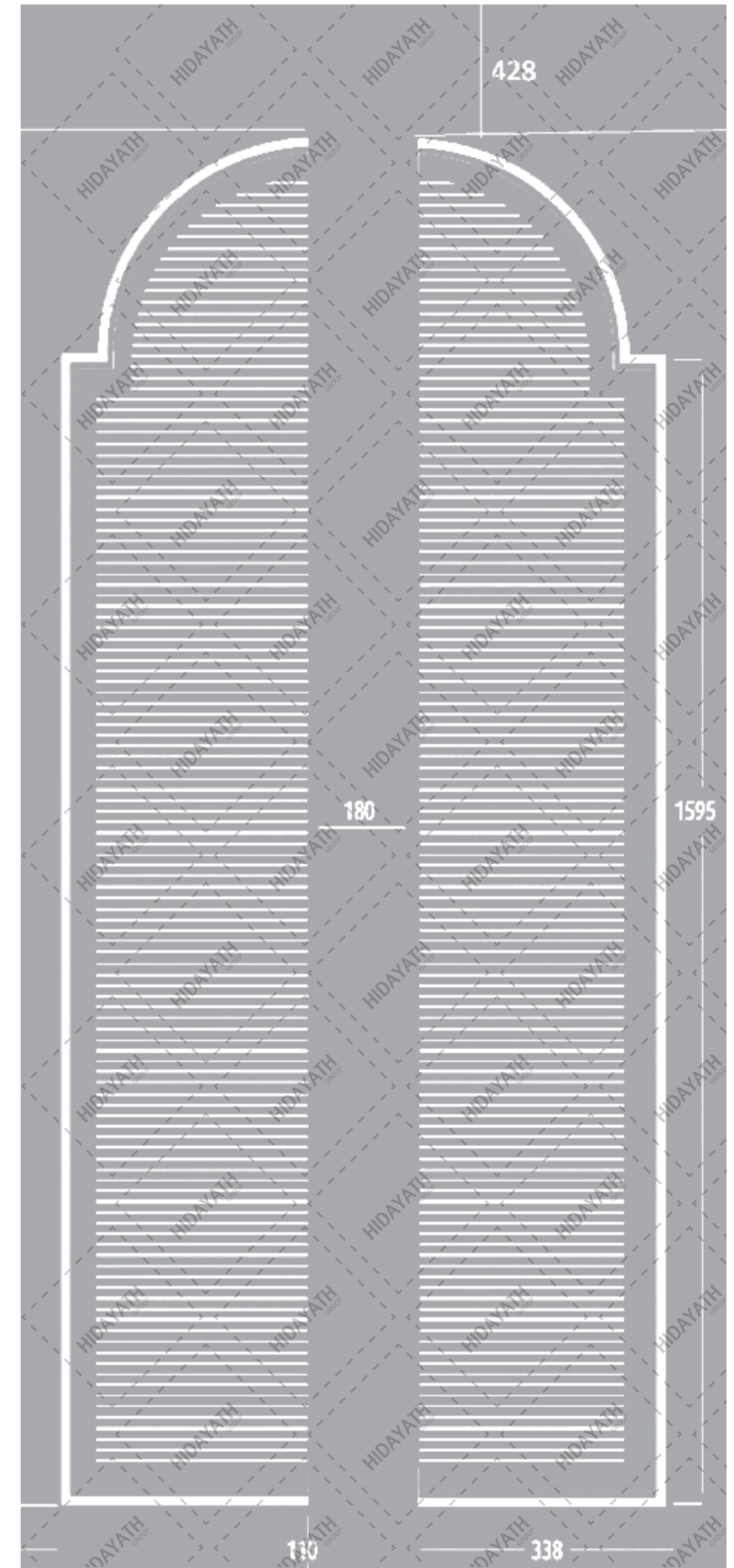
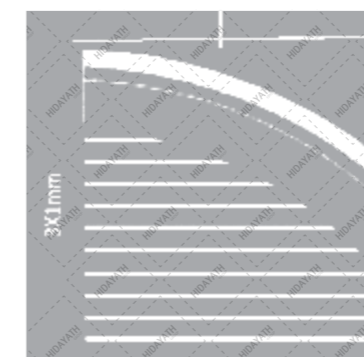

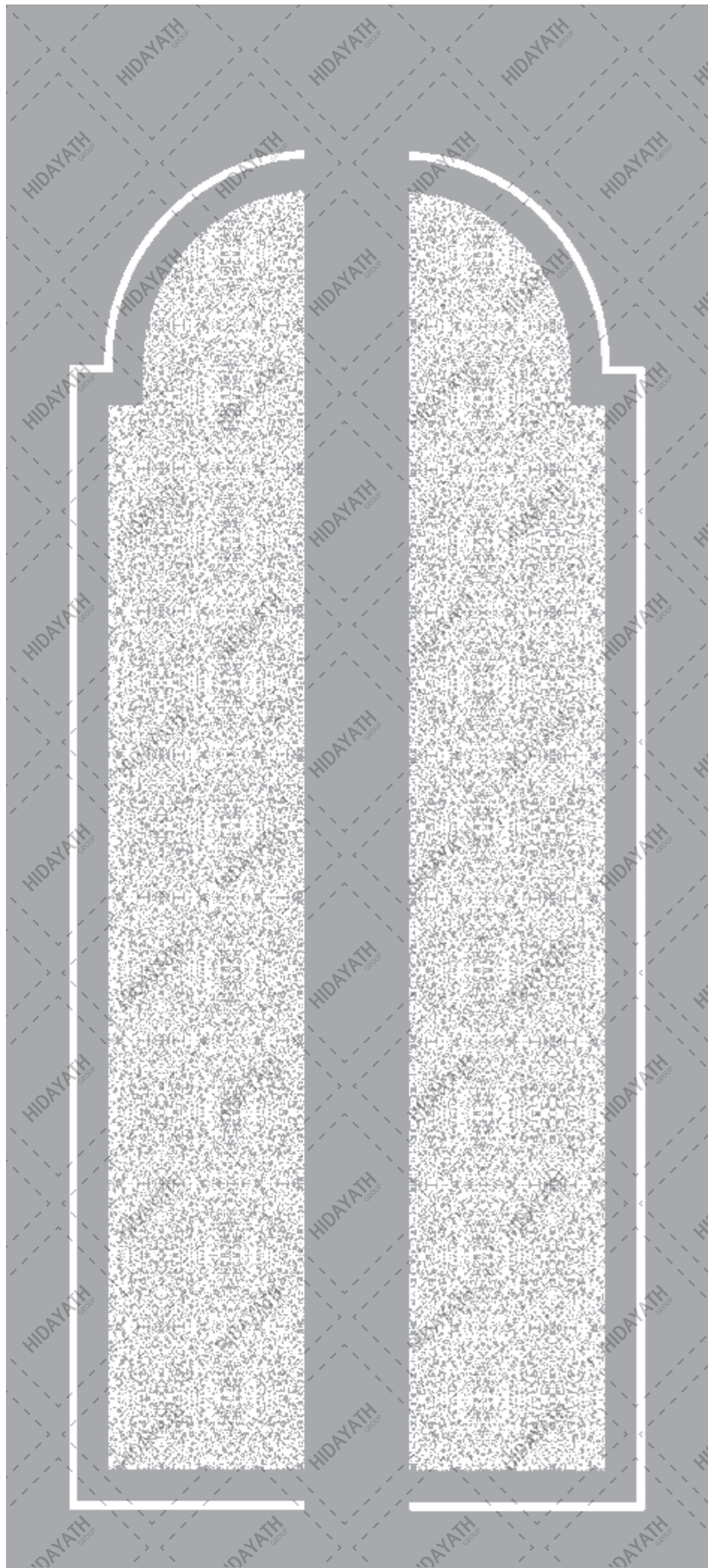

CODE
HTC 1054

Full sheet pattern orientation - **white** areas are etched.
Maximum Size: 8ft. x 4ft. (Etching)

Different finishes and colours are available on request.

Designs may be Waterjet cut or Laser cut as per requirement. Some designs may come with borders.

For detailed information kindly consult our sales personnel.

Note: The displayed illustration is for orientation only. Actual pattern may vary from the pattern shown.

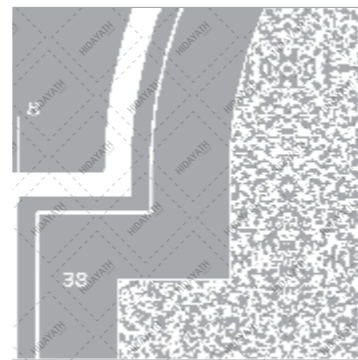

CODE
HTC 1055

Full sheet pattern orientation - **white** areas are etched.
Maximum Size: 8ft. x 4ft. (Etching)

Different finishes and colours are available on request.

Designs may be Waterjet cut or Laser cut as per requirement. Some designs may come with borders.

For detailed information kindly consult our sales personnel.

Note: The displayed illustration is for orientation only. Actual pattern may vary from the pattern shown.

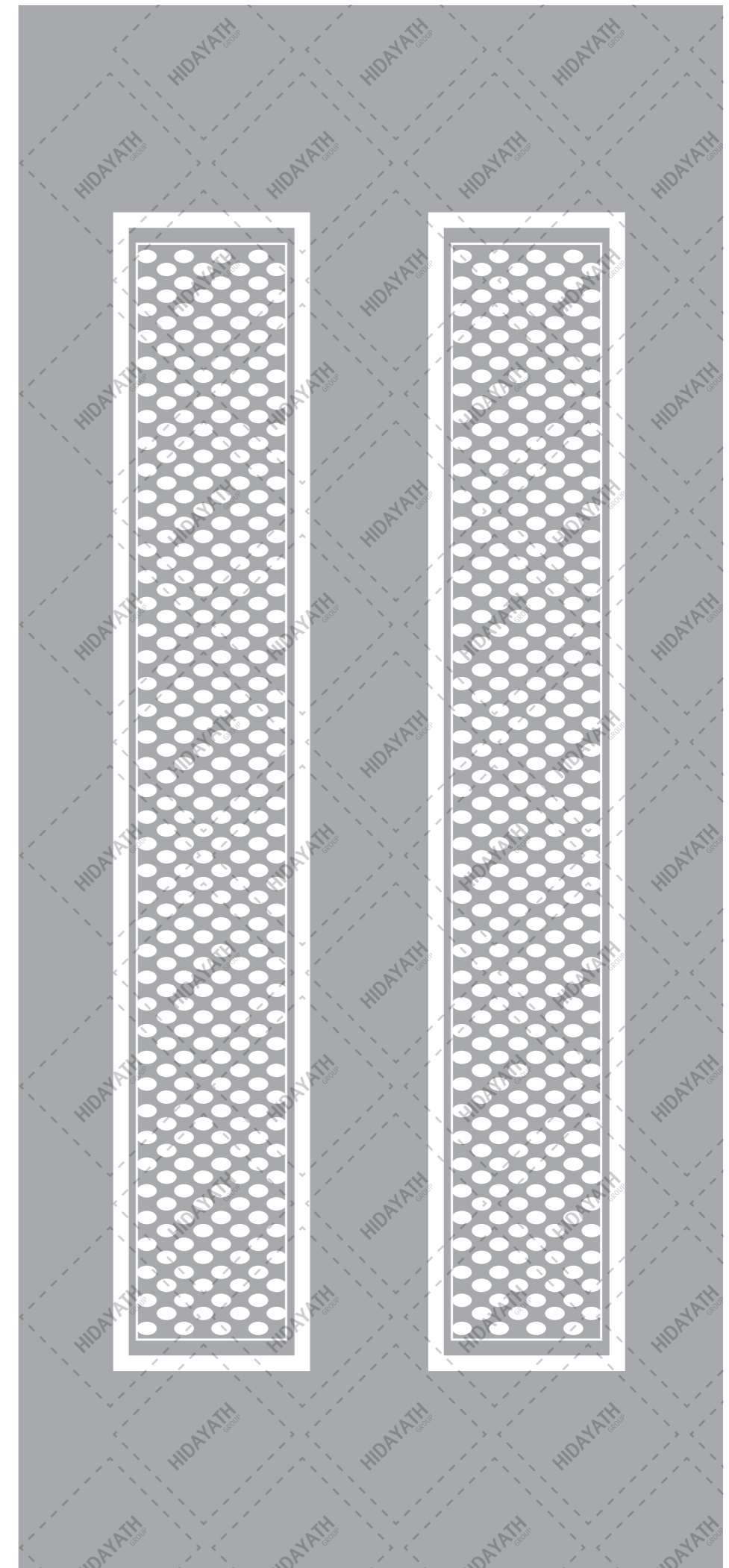
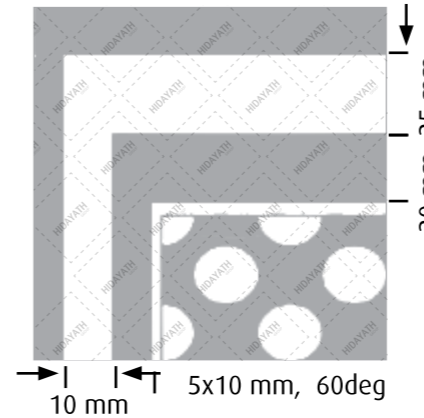

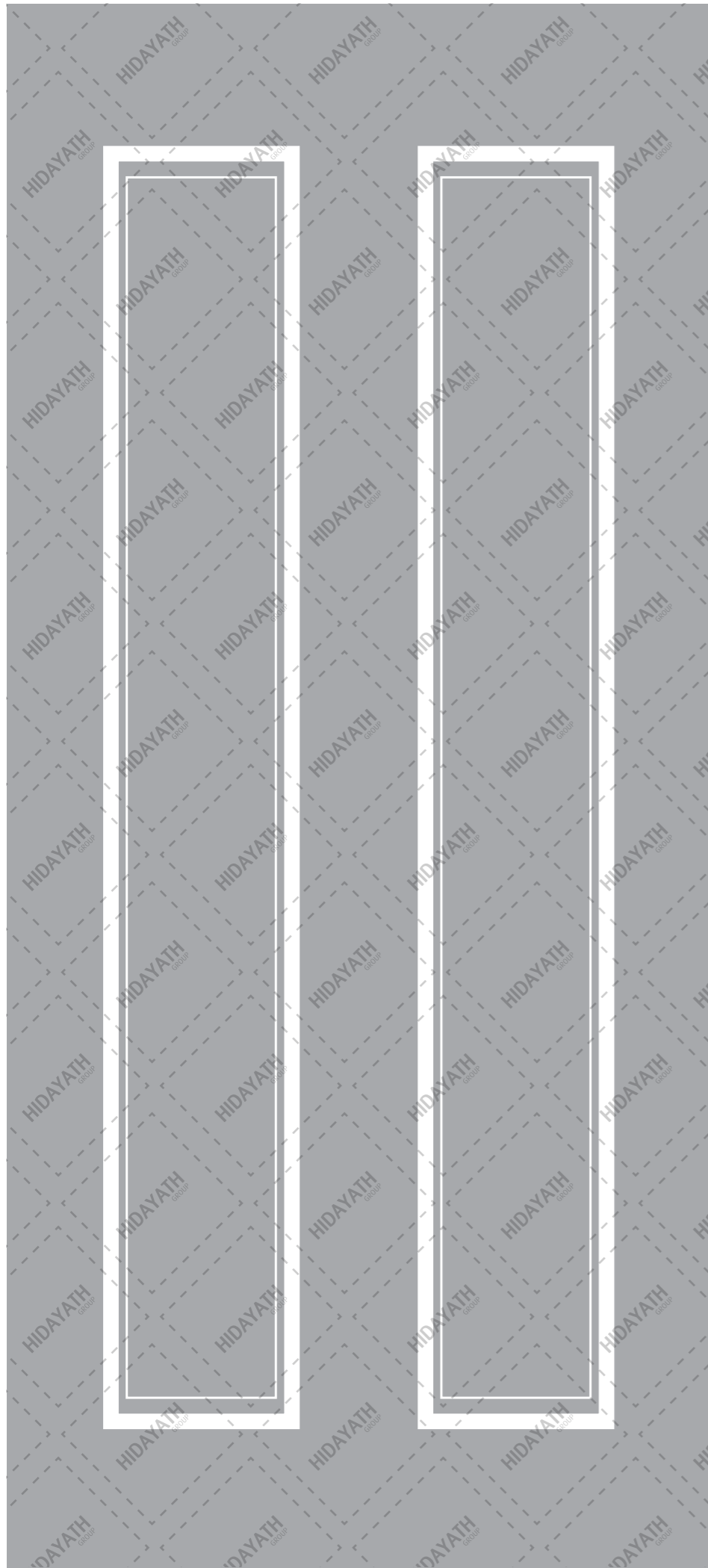

CODE
HTC 1057

Full sheet pattern orientation - **white** areas are etched.
Maximum Size: 8ft. x 4ft. (Etching)

Different finishes and colours are available on request.

Designs may be Waterjet cut or Laser cut as per requirement.
Some designs may come with borders.

For detailed information kindly consult our sales personnel.

Note: The displayed illustration is for orientation only. Actual pattern may vary from the pattern shown.

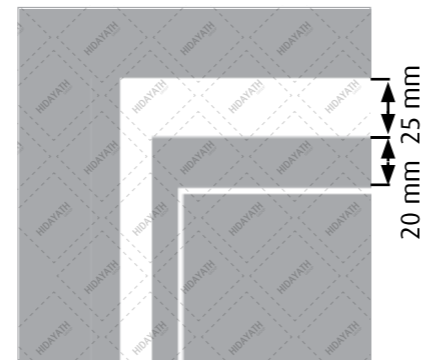

CODE
HTC 1058

Full sheet pattern orientation - **white** areas are etched.
Maximum Size: 8ft. x 4ft. (Etching)

Different finishes and colours are available on request.

Designs may be Waterjet cut or Laser cut as per requirement.
Some designs may come with borders.

For detailed information kindly consult our sales personnel.

Note: The displayed illustration is for orientation only. Actual pattern may vary from the pattern shown.

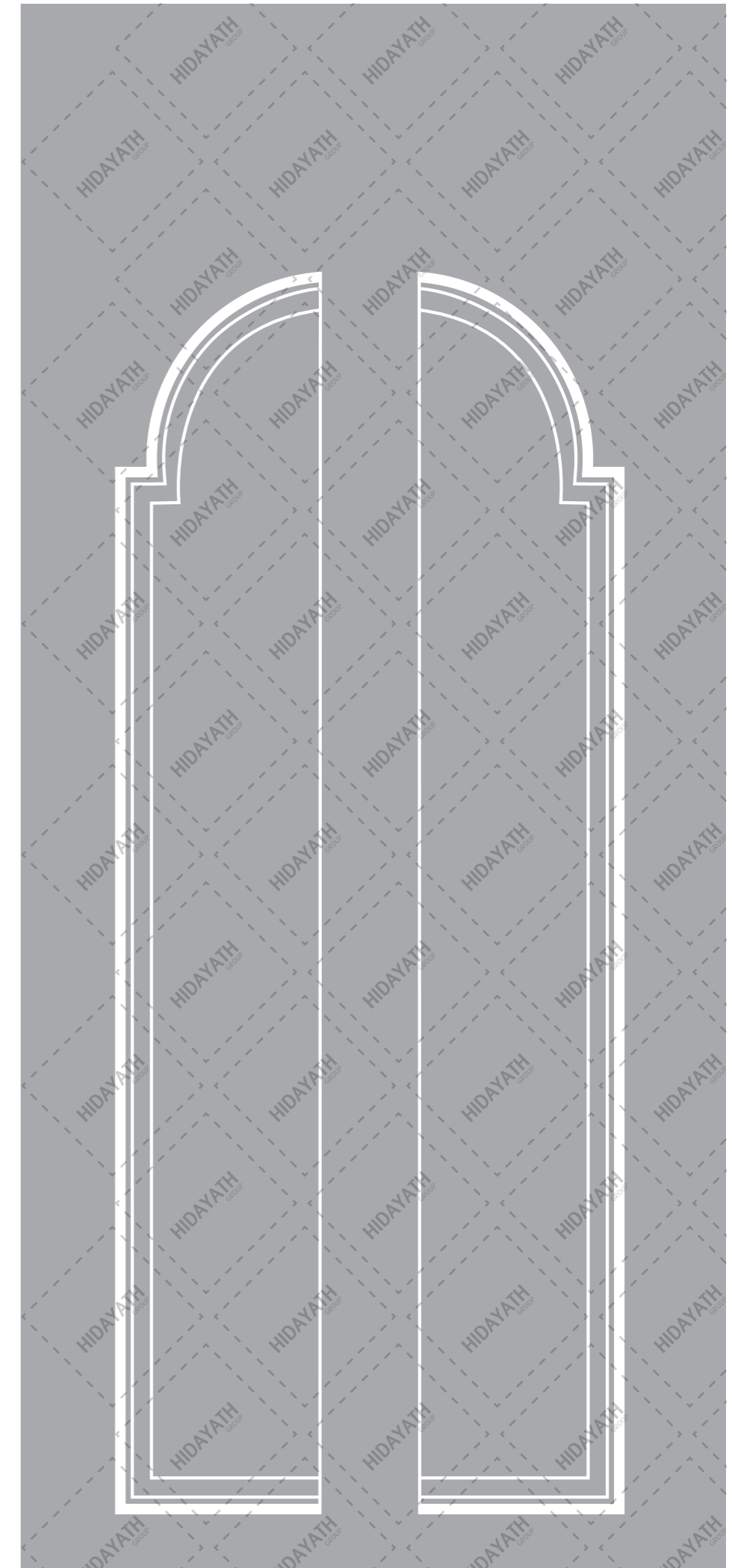
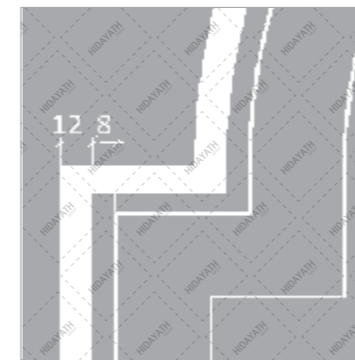

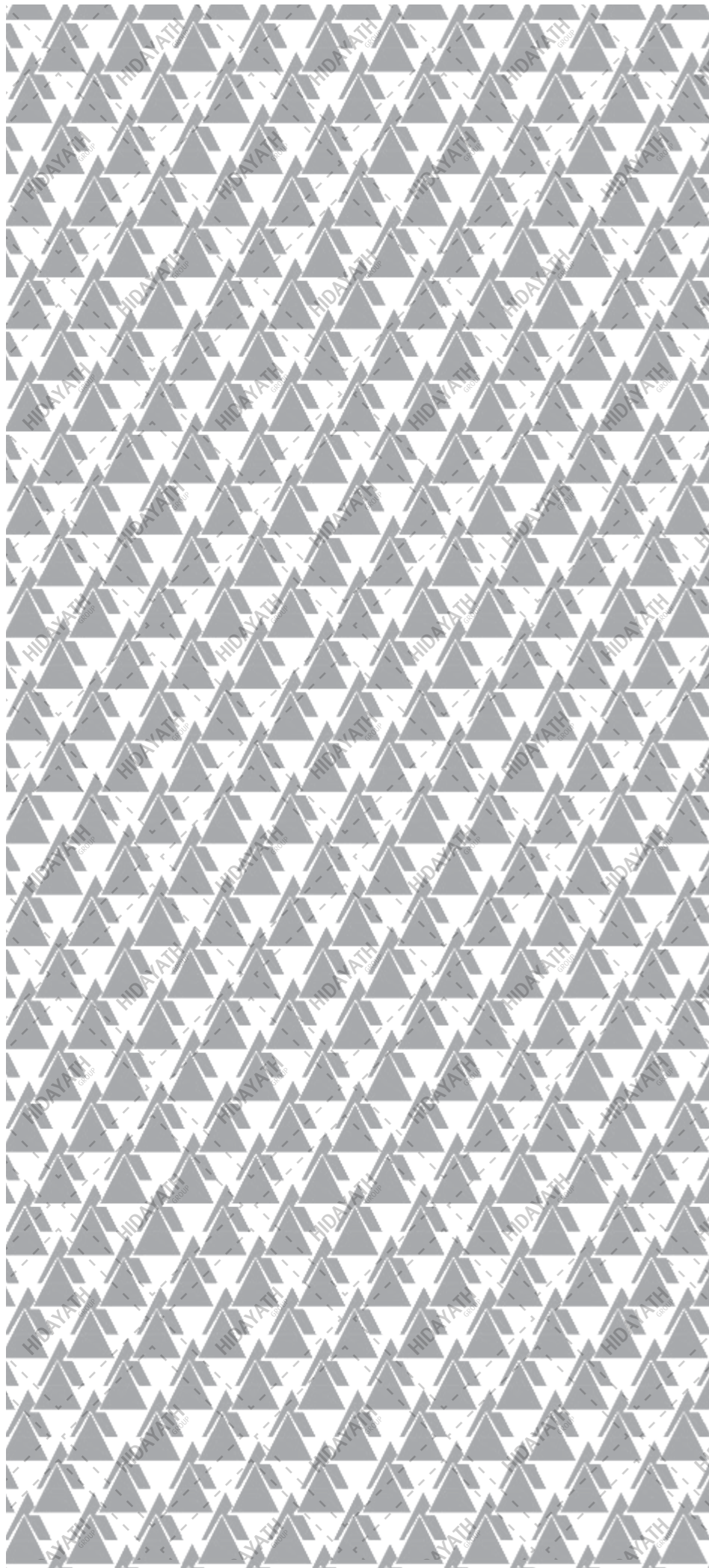

CODE
HTC 1060

Full sheet pattern orientation - **white** areas are etched.
Maximum Size: 8ft. x 4ft. (Etching)

Different finishes and colours are available on request.

Designs may be Waterjet cut or Laser cut as per requirement. Some designs may come with borders.

For detailed information kindly consult our sales personnel.

Note: The displayed illustration is for orientation only. Actual pattern may vary from the pattern shown.

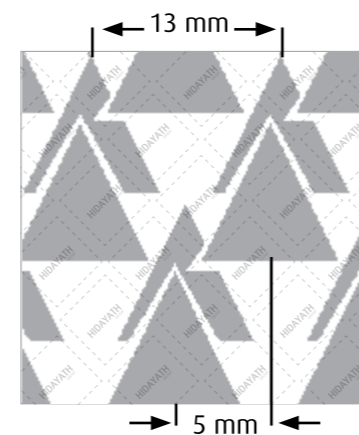

CODE
HTC 1061

Full sheet pattern orientation - **white** areas are etched.
Maximum Size: 8ft. x 4ft. (Etching)

Different finishes and colours are available on request.

Designs may be Waterjet cut or Laser cut as per requirement. Some designs may come with borders.

For detailed information kindly consult our sales personnel.

Note: The displayed illustration is for orientation only. Actual pattern may vary from the pattern shown.

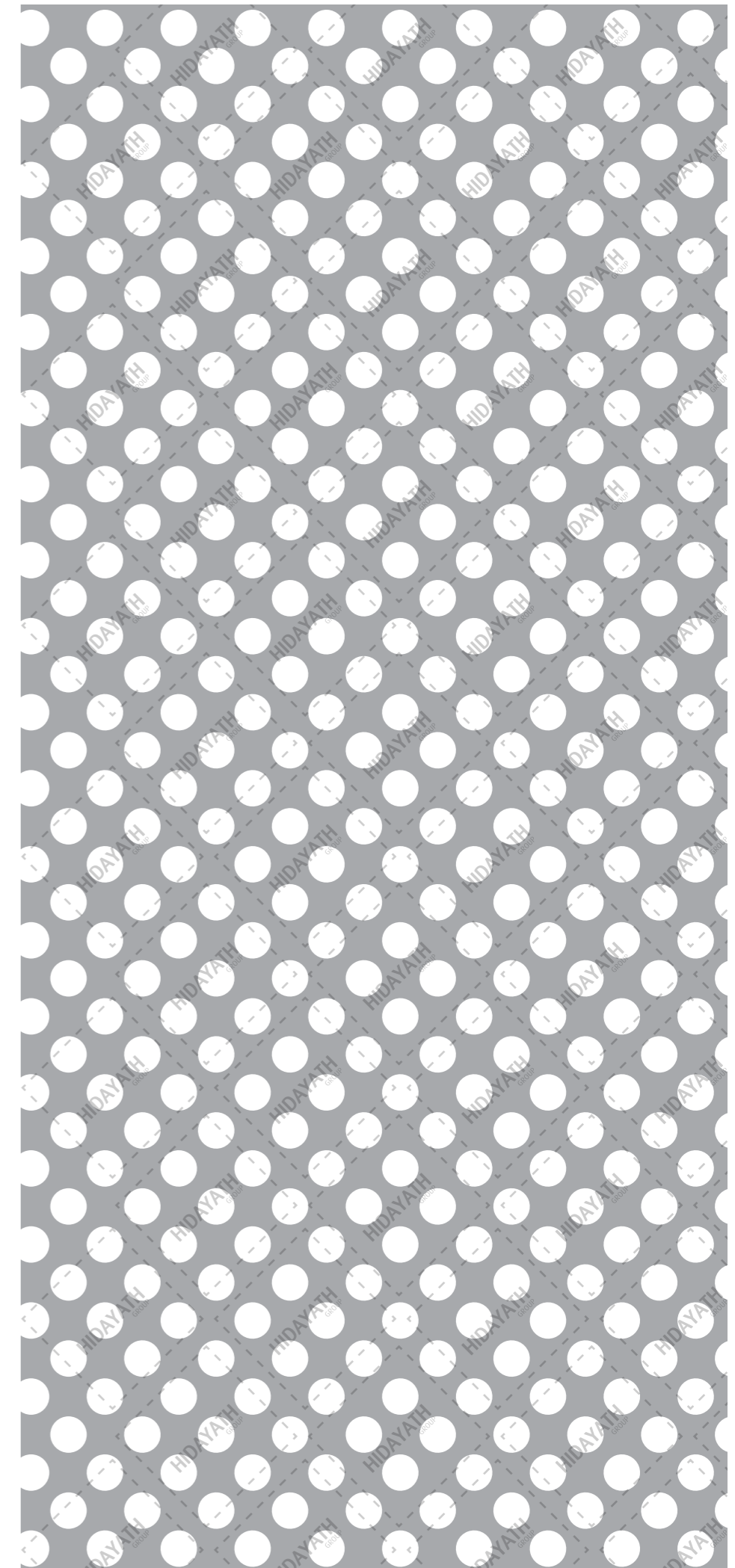
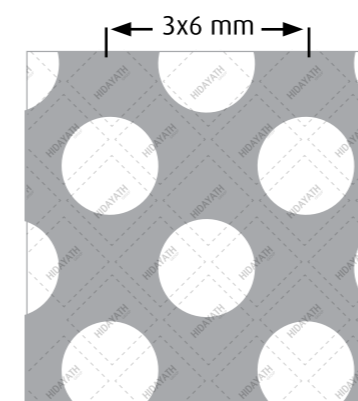

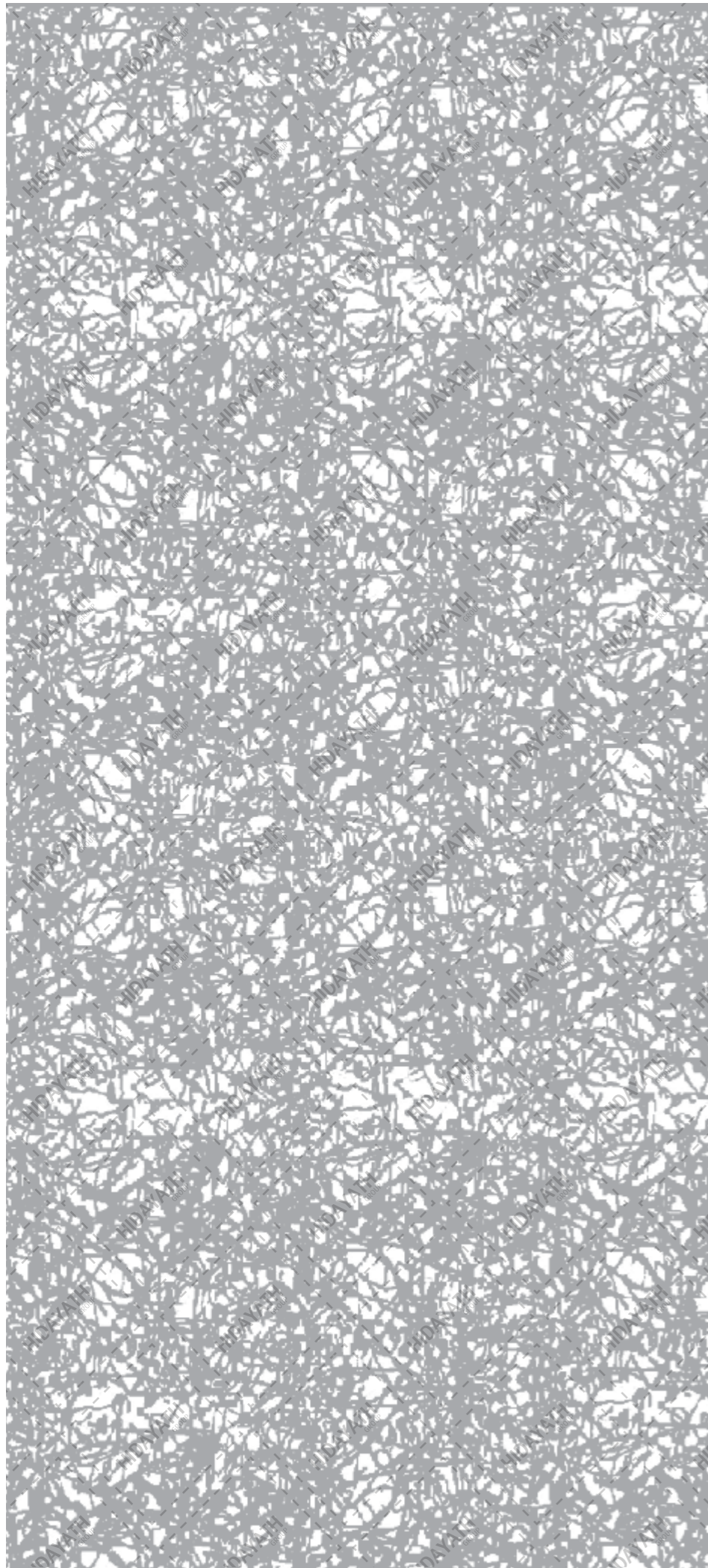

CODE
HTC 1062

Full sheet pattern orientation - **white** areas are etched.
Maximum Size: 8ft. x 4ft. (Etching)

Different finishes and colours are available on request.

Designs may be Waterjet cut or Laser cut as per requirement. Some designs may come with borders.

For detailed information kindly consult our sales personnel.

Note: The displayed illustration is for orientation only. Actual pattern may vary from the pattern shown.

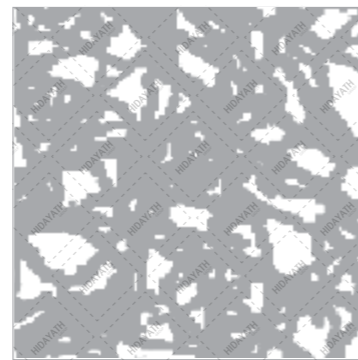

CODE
HTC 1063

Full sheet pattern orientation - **white** areas are etched.
Maximum Size: 8ft. x 4ft. (Etching)

Different finishes and colours are available on request.

Designs may be Waterjet cut or Laser cut as per requirement. Some designs may come with borders.

For detailed information kindly consult our sales personnel.

Note: The displayed illustration is for orientation only. Actual pattern may vary from the pattern shown.

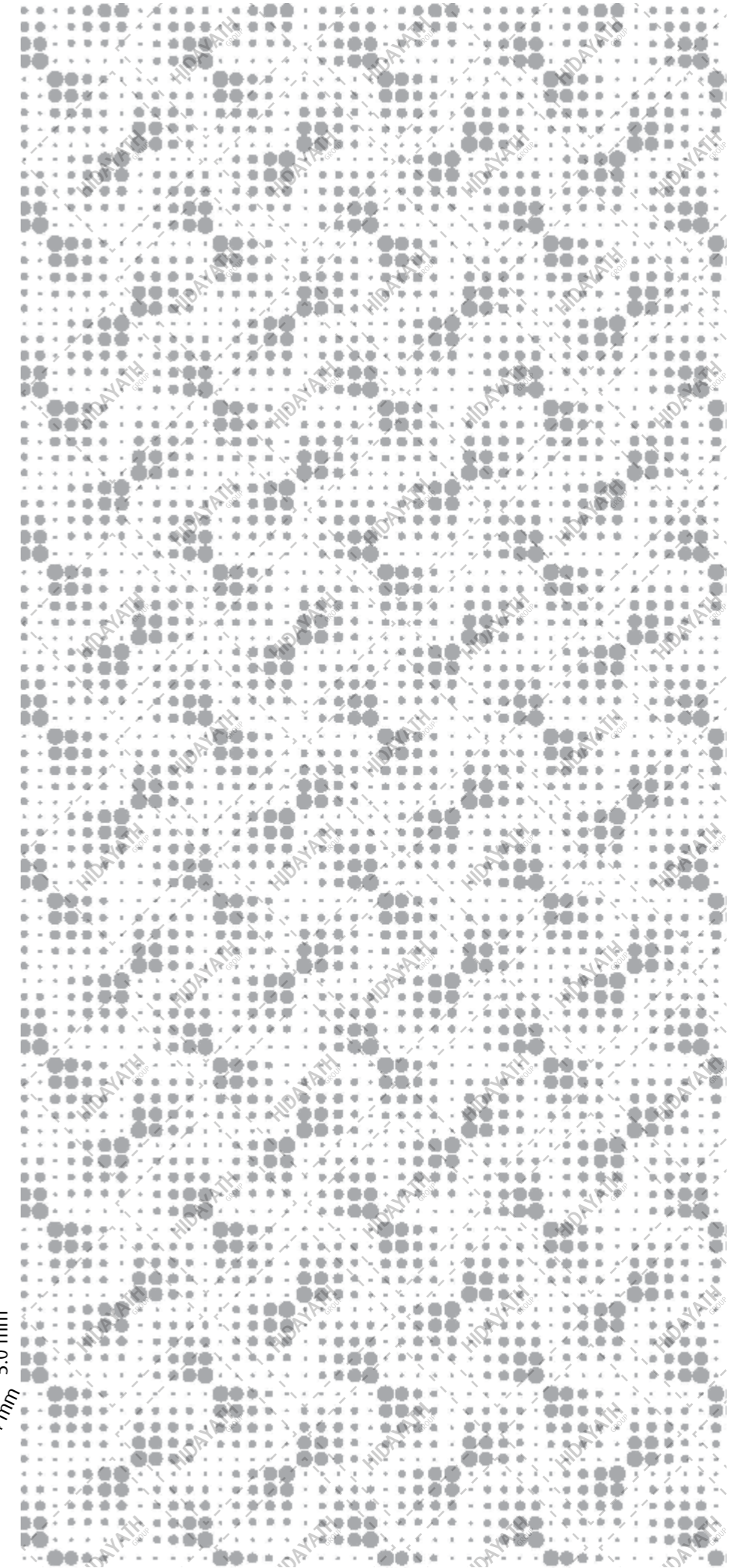
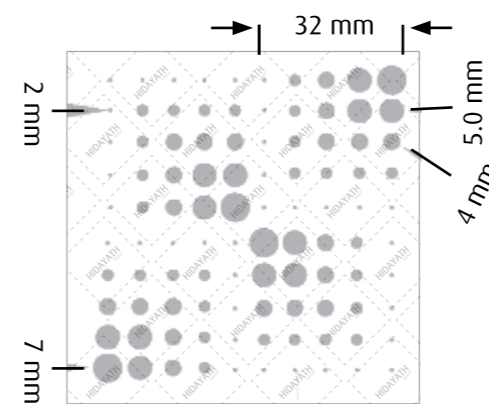

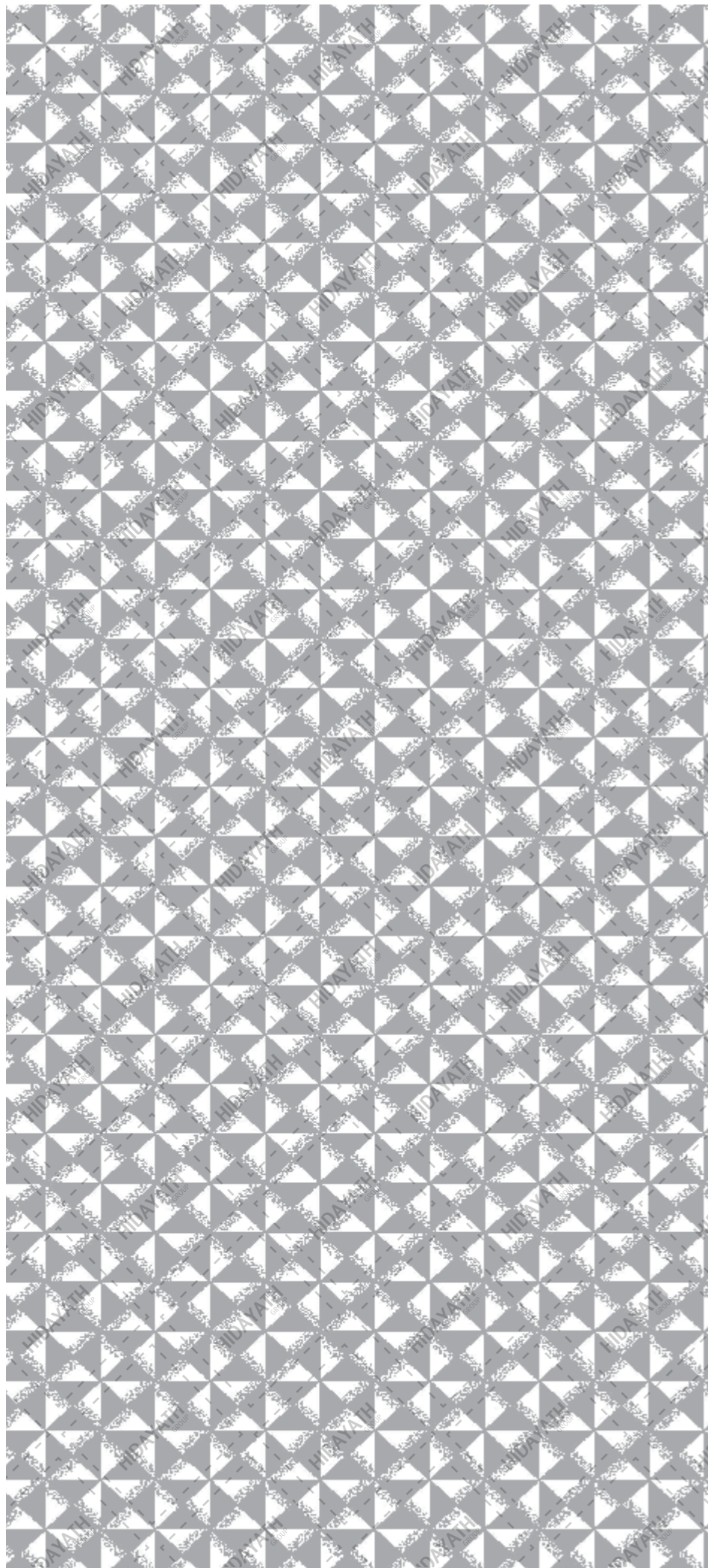

CODE
HTC 1064

Full sheet pattern orientation - **white** areas are etched.
Maximum Size: 8ft. x 4ft. (Etching)

Different finishes and colours are available on request.

Designs may be Waterjet cut or Laser cut as per requirement. Some designs may come with borders.

For detailed information kindly consult our sales personnel.

Note: The displayed illustration is for orientation only. Actual pattern may vary from the pattern shown.

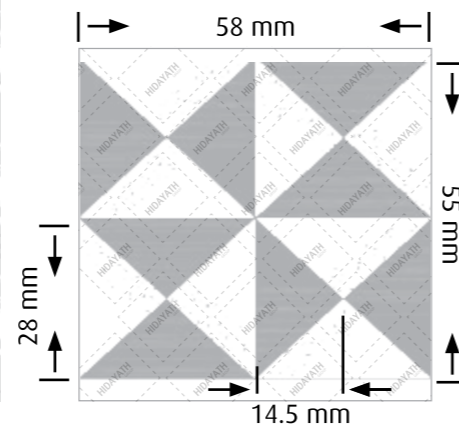

CODE
HTC 1066

Full sheet pattern orientation - **white** areas are etched.
Maximum Size: 8ft. x 4ft. (Etching)

Different finishes and colours are available on request.

Designs may be Waterjet cut or Laser cut as per requirement. Some designs may come with borders.

For detailed information kindly consult our sales personnel.

Note: The displayed illustration is for orientation only. Actual pattern may vary from the pattern shown.

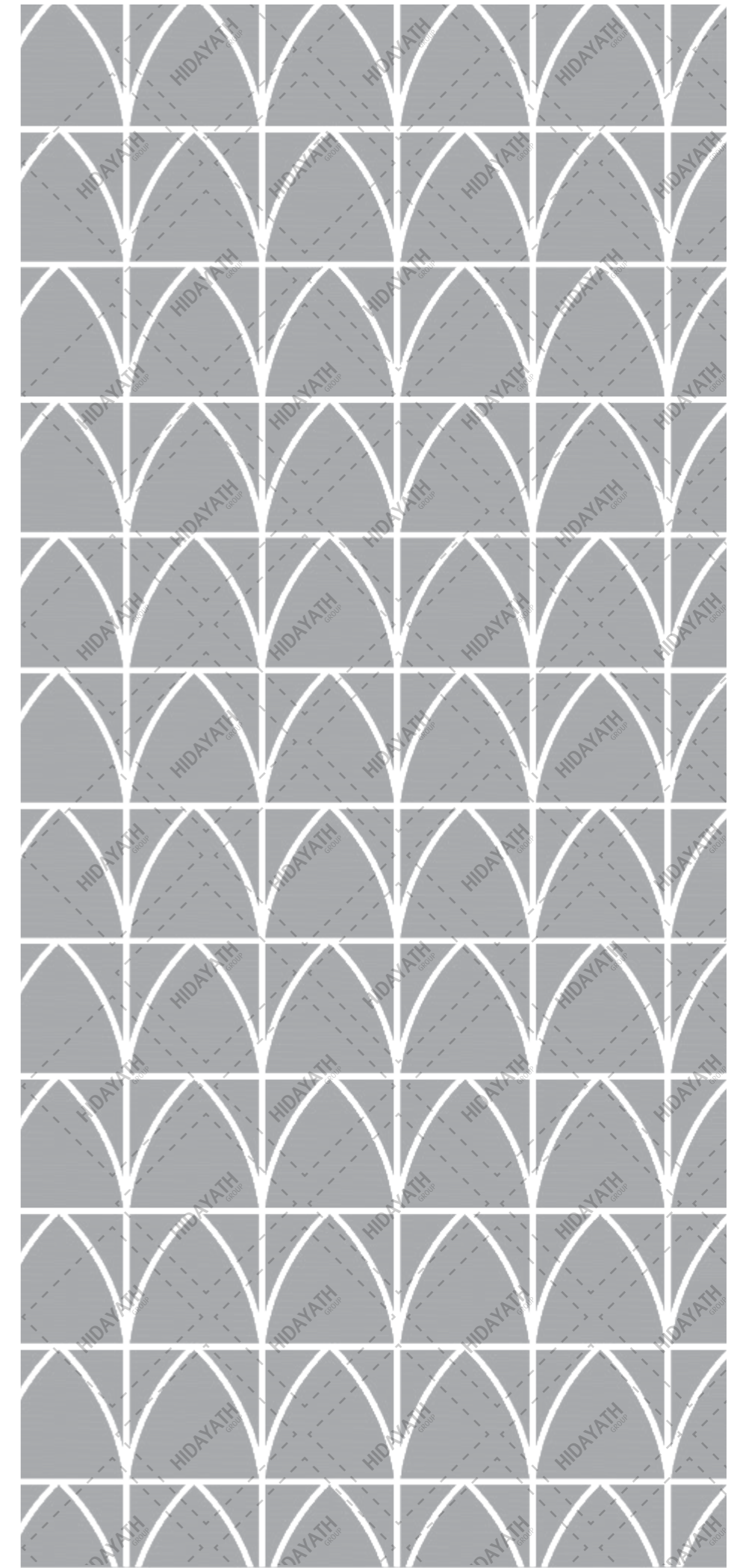
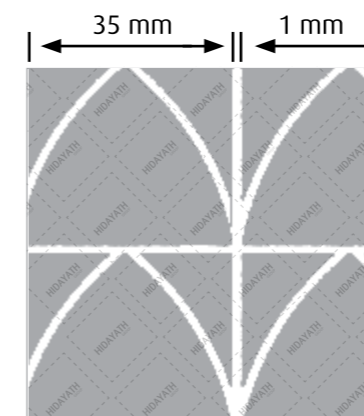

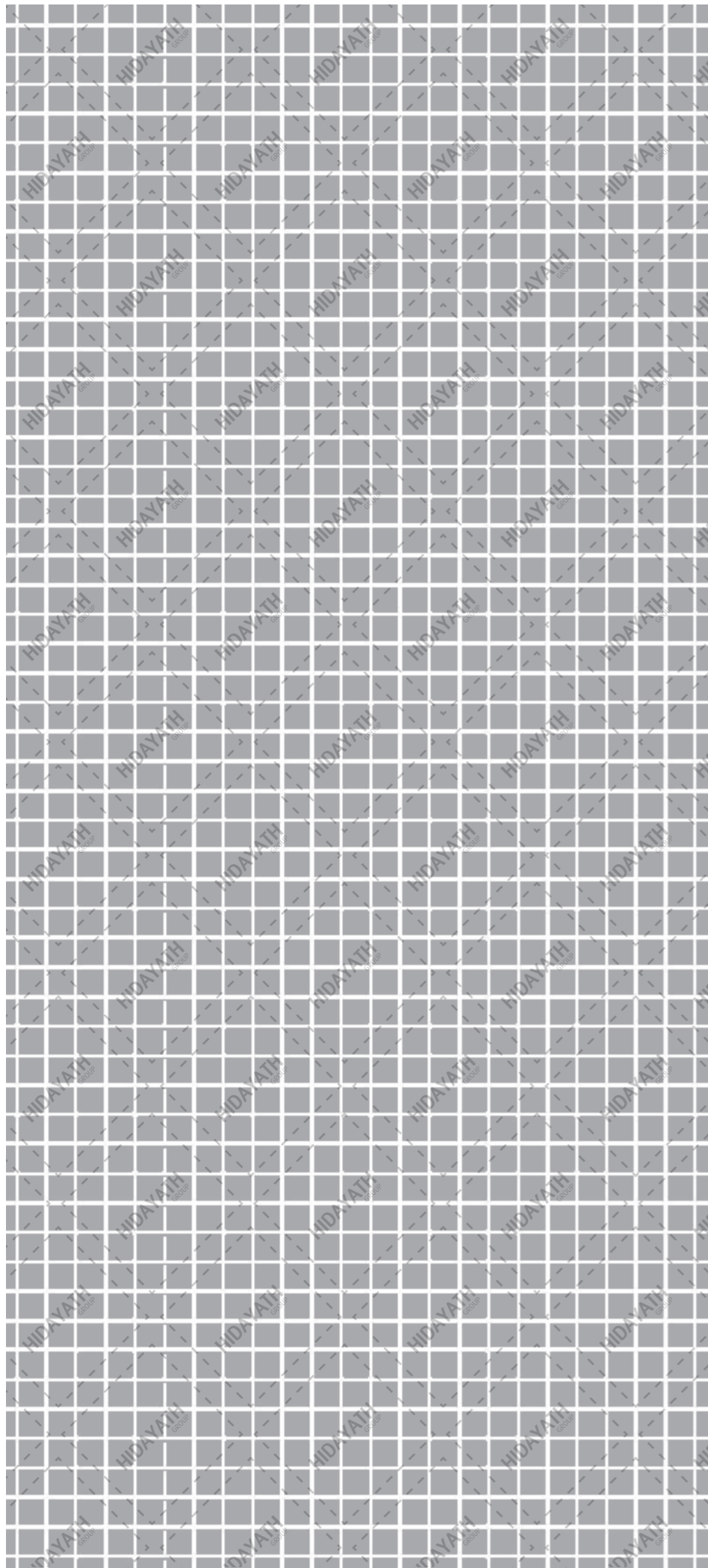

CODE
HTC 1067

Full sheet pattern orientation - **white** areas are etched.
Maximum Size: 8ft. x 4ft. (Etching)

Different finishes and colours are available on request.

Designs may be Waterjet cut or Laser cut as per requirement. Some designs may come with borders.

For detailed information kindly consult our sales personnel.

Note: The displayed illustration is for orientation only. Actual pattern may vary from the pattern shown.

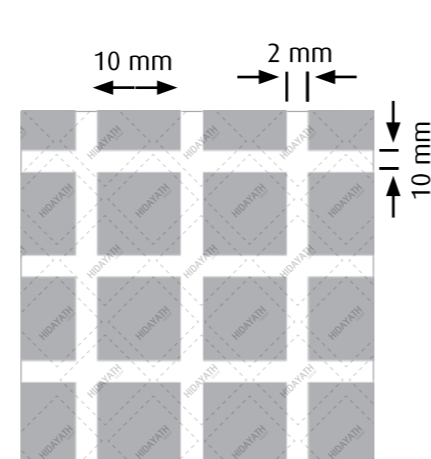

CODE
HTC 1068

Full sheet pattern orientation - **white** areas are etched.
Maximum Size: 8ft. x 4ft. (Etching)

Different finishes and colours are available on request.

Designs may be Waterjet cut or Laser cut as per requirement. Some designs may come with borders.

For detailed information kindly consult our sales personnel.

Note: The displayed illustration is for orientation only. Actual pattern may vary from the pattern shown.

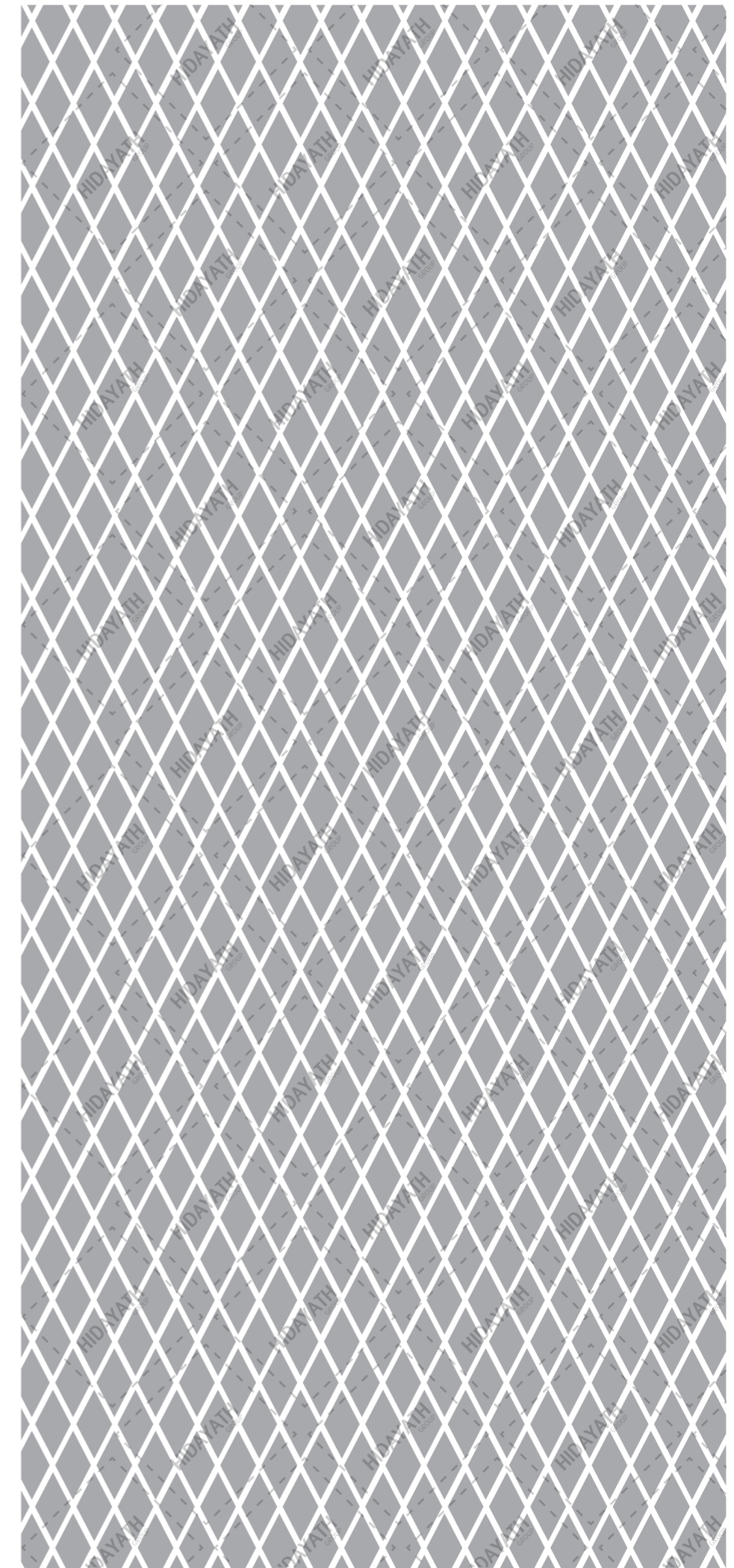
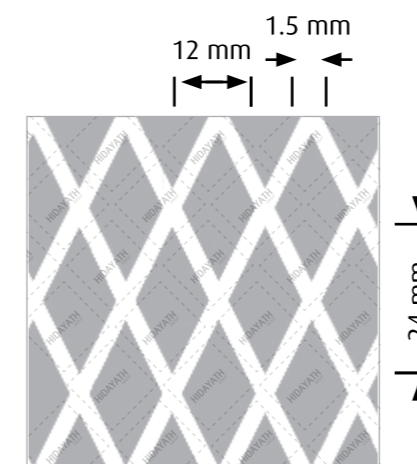

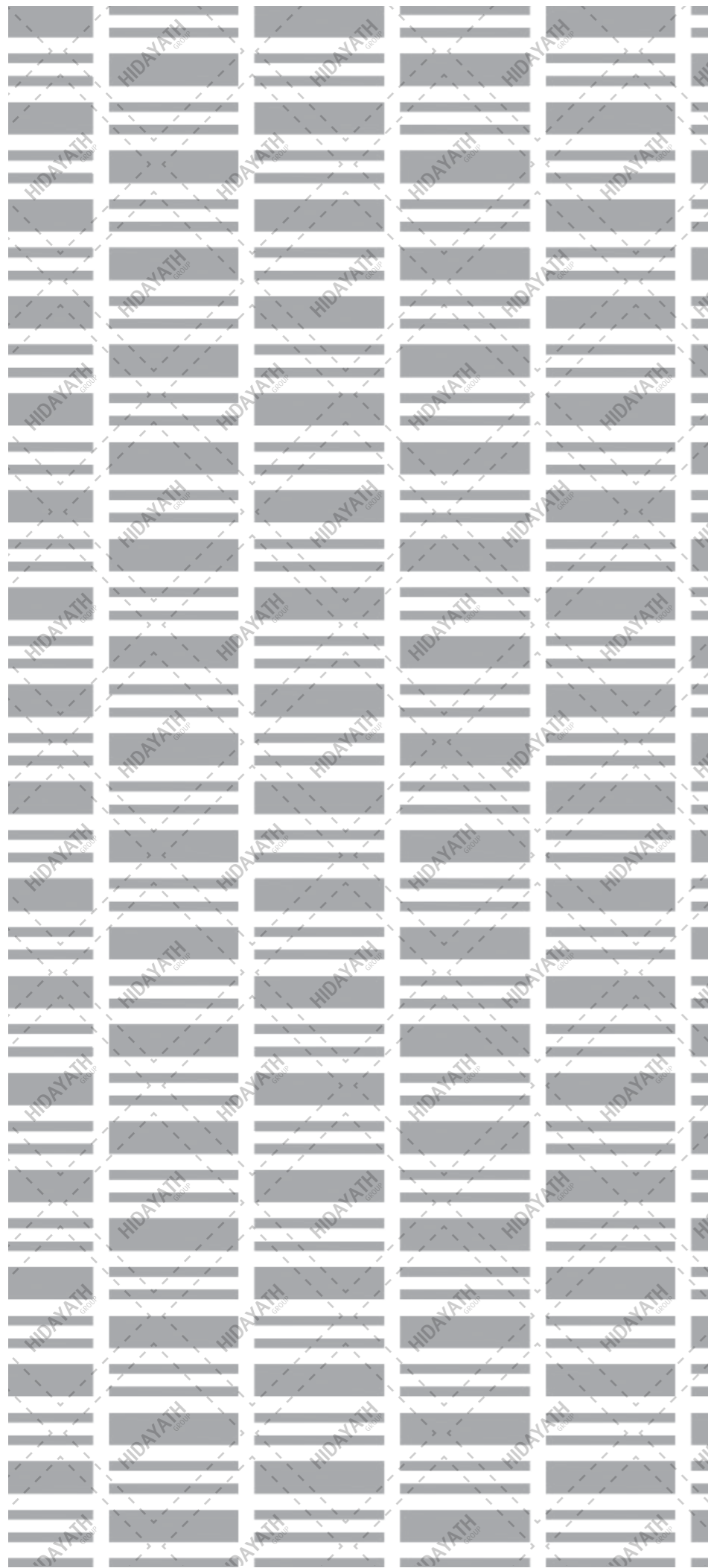

CODE
HTC 1069

Full sheet pattern orientation - **white** areas are etched.
Maximum Size: 8ft. x 4ft. (Etching)

Different finishes and colours are available on request.

Designs may be Waterjet cut or Laser cut as per requirement. Some designs may come with borders.

For detailed information kindly consult our sales personnel.

Note: The displayed illustration is for orientation only. Actual pattern may vary from the pattern shown.

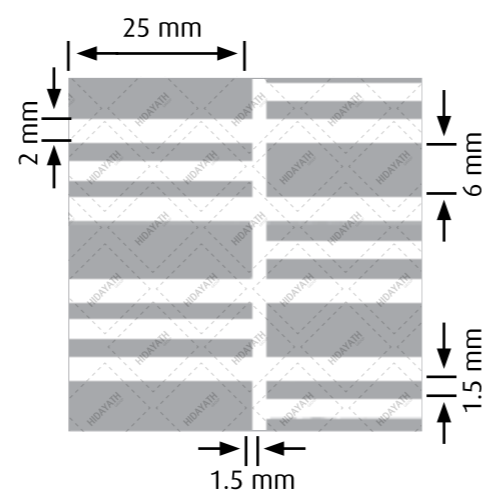

CODE
HTC 1071

Full sheet pattern orientation - **white** areas are etched.
Maximum Size: 8ft. x 4ft. (Etching)

Different finishes and colours are available on request.

Designs may be Waterjet cut or Laser cut as per requirement. Some designs may come with borders.

For detailed information kindly consult our sales personnel.

Note: The displayed illustration is for orientation only. Actual pattern may vary from the pattern shown.

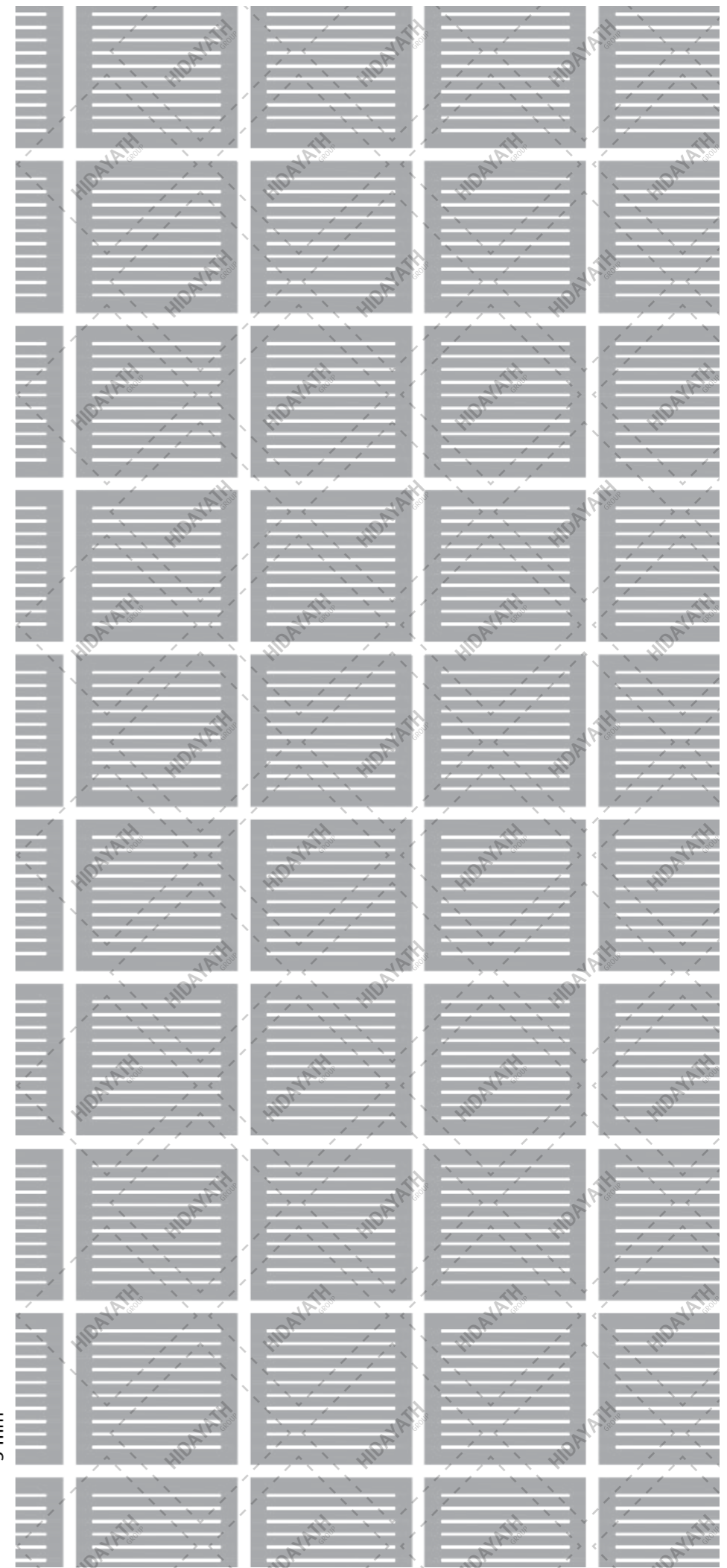
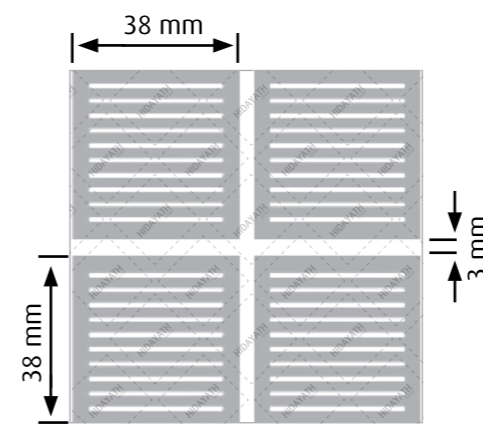

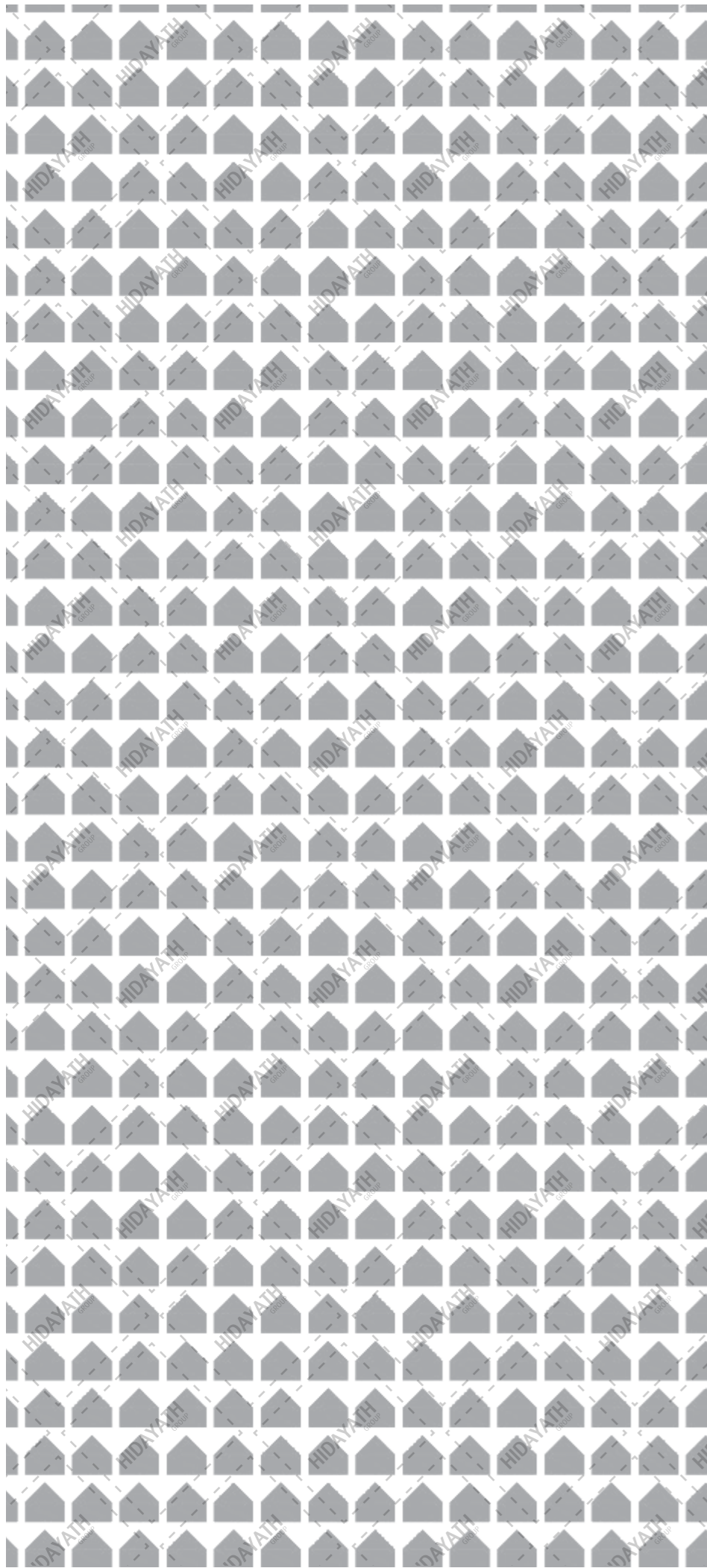

CODE
HTC 1072

Full sheet pattern orientation - **white** areas are etched.
Maximum Size: 8ft. x 4ft. (Etching)

Different finishes and colours are available on request.

Designs may be Waterjet cut or Laser cut as per requirement. Some designs may come with borders.

For detailed information kindly consult our sales personnel.

Note: The displayed illustration is for orientation only. Actual pattern may vary from the pattern shown.

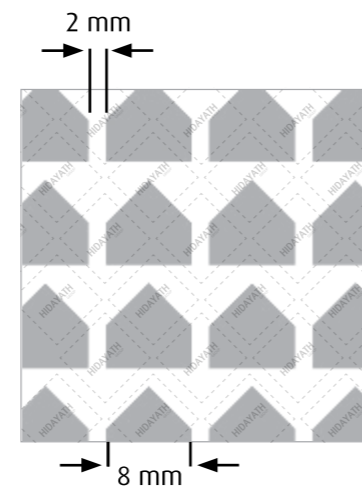

CODE
HTC 1073

Full sheet pattern orientation - **white** areas are etched.
Maximum Size: 8ft. x 4ft. (Etching)

Different finishes and colours are available on request.

Designs may be Waterjet cut or Laser cut as per requirement. Some designs may come with borders.

For detailed information kindly consult our sales personnel.

Note: The displayed illustration is for orientation only. Actual pattern may vary from the pattern shown.

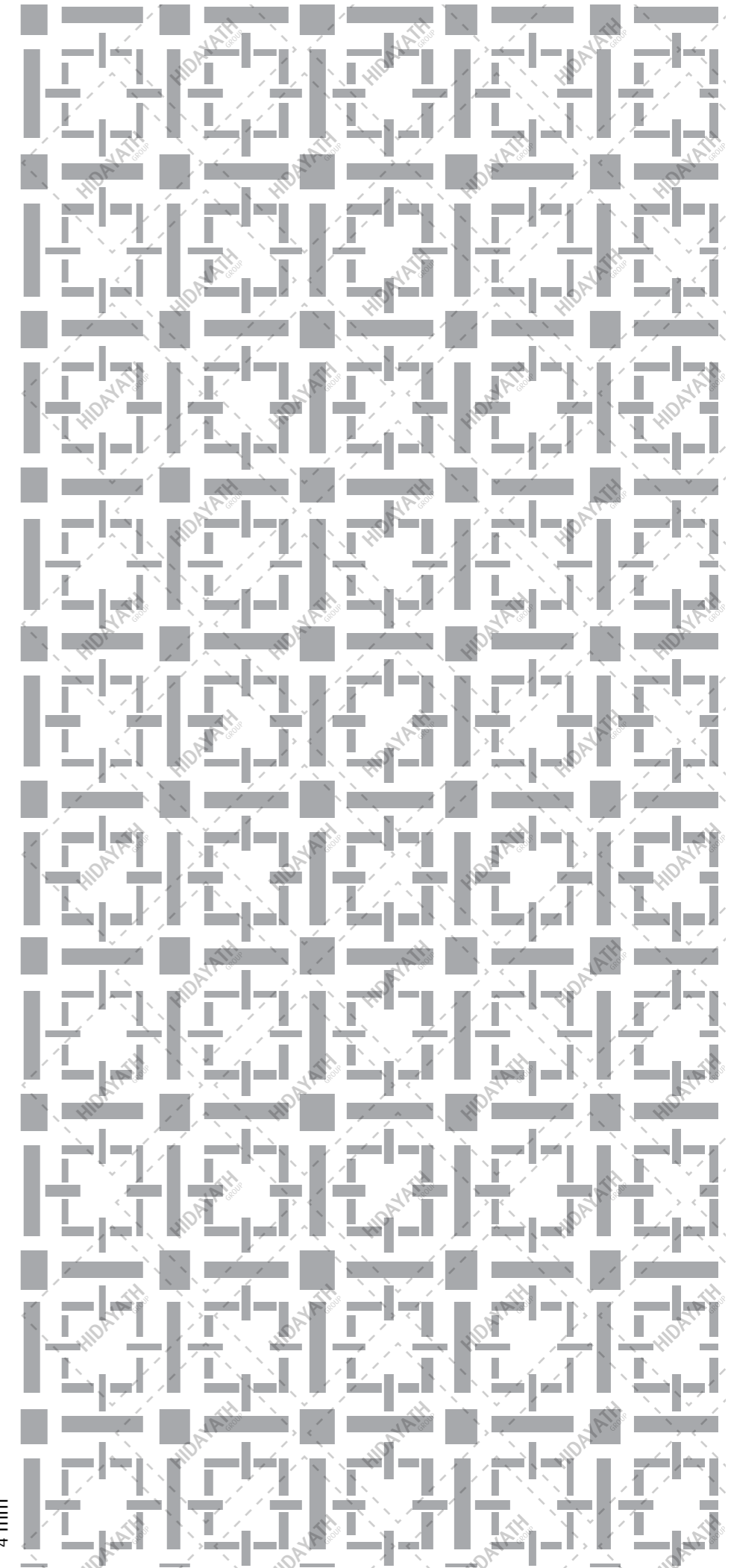
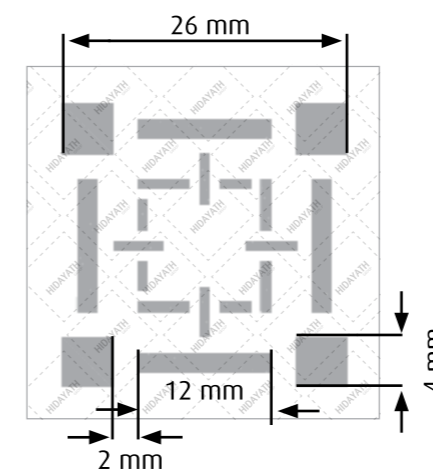



CODE
HTC 1074

Full sheet pattern orientation - **white** areas are etched.
Maximum Size: 8ft. x 4ft. (Etching)

Different finishes and colours are available on request.

Designs may be Waterjet cut or Laser cut as per requirement. Some designs may come with borders.

For detailed information kindly consult our sales personnel.

Note: The displayed illustration is for orientation only. Actual pattern may vary from the pattern shown.

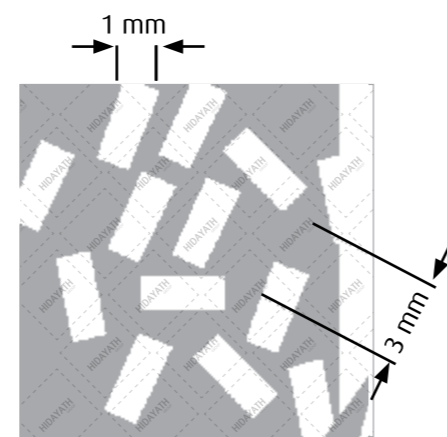

CODE
HTC 1075

Full sheet pattern orientation - **white** areas are etched.
Maximum Size: 8ft. x 4ft. (Etching)

Different finishes and colours are available on request.

Designs may be Waterjet cut or Laser cut as per requirement. Some designs may come with borders.

For detailed information kindly consult our sales personnel.

Note: The displayed illustration is for orientation only. Actual pattern may vary from the pattern shown.

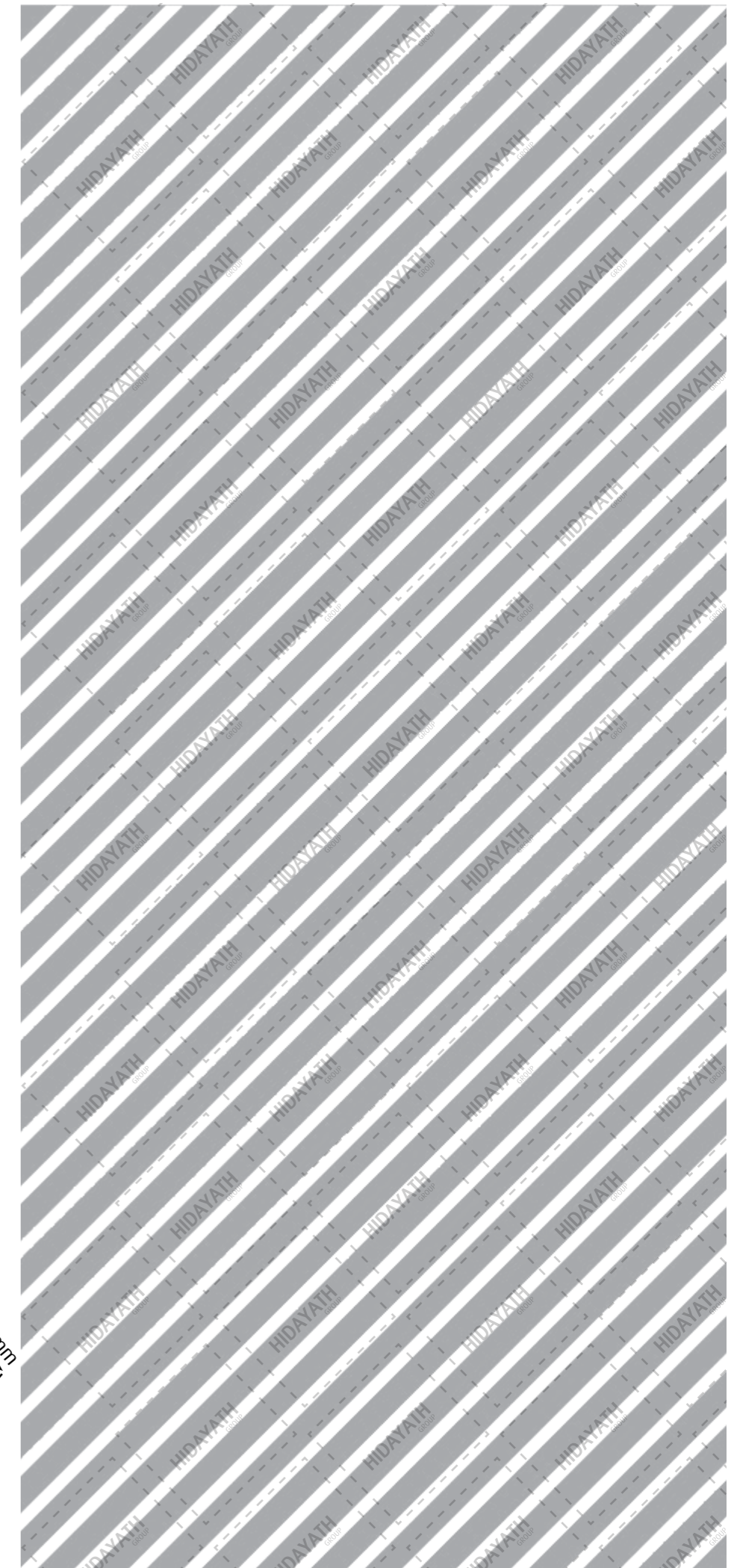
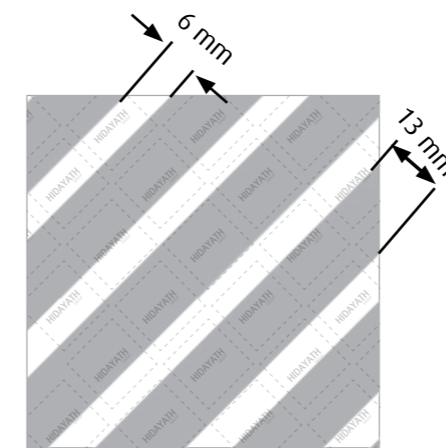

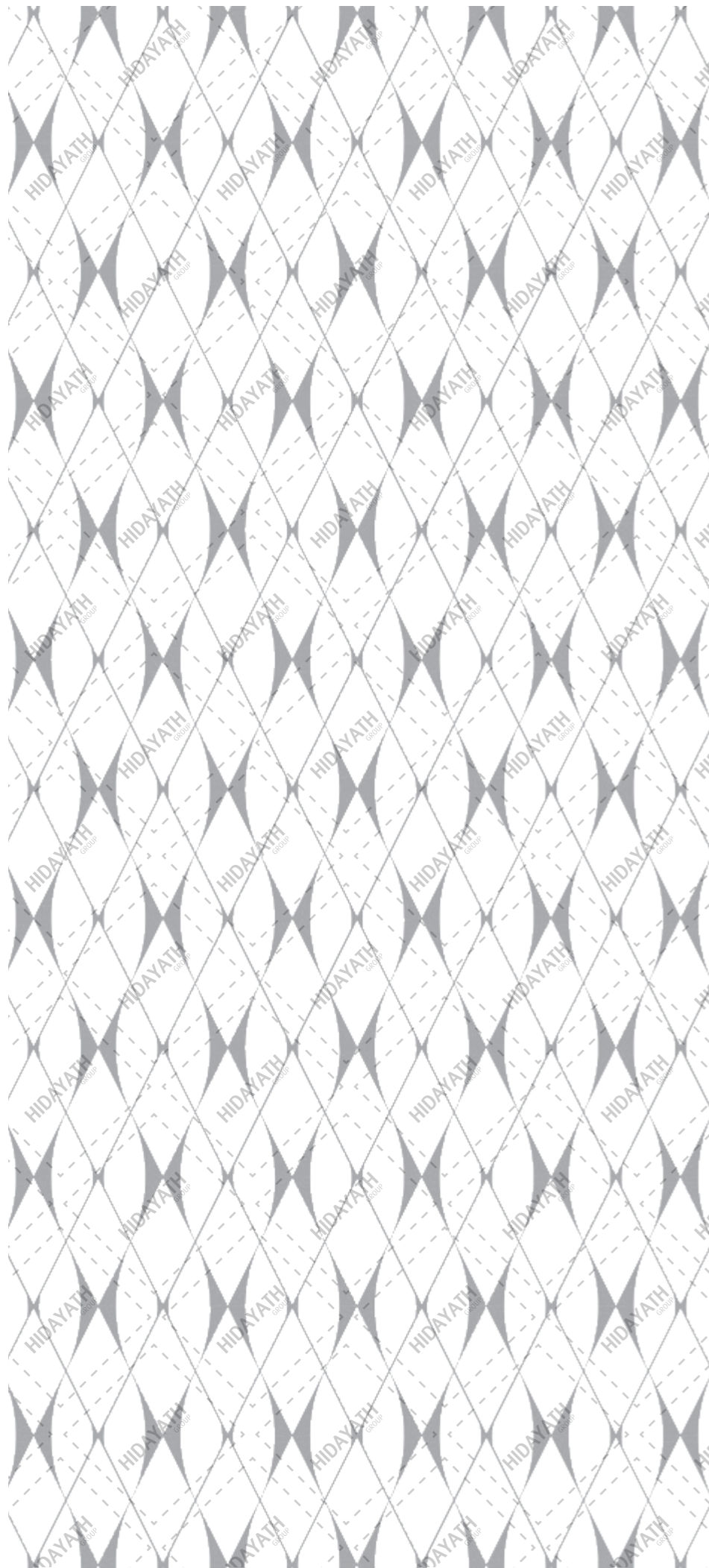

CODE
HTC 1076

Full sheet pattern orientation - **white** areas are etched.
Maximum Size: 8ft. x 4ft. (Etching)

Different finishes and colours are available on request.

Designs may be Waterjet cut or Laser cut as per requirement. Some designs may come with borders.

For detailed information kindly consult our sales personnel.

Note: The displayed illustration is for orientation only. Actual pattern may vary from the pattern shown.

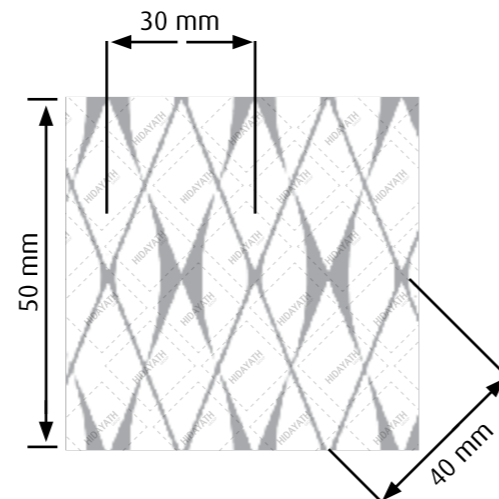

CODE
HTC 1077

Full sheet pattern orientation - **white** areas are etched.
Maximum Size: 8ft. x 4ft. (Etching)

Different finishes and colours are available on request.

Designs may be Waterjet cut or Laser cut as per requirement. Some designs may come with borders.

For detailed information kindly consult our sales personnel.

Note: The displayed illustration is for orientation only. Actual pattern may vary from the pattern shown.

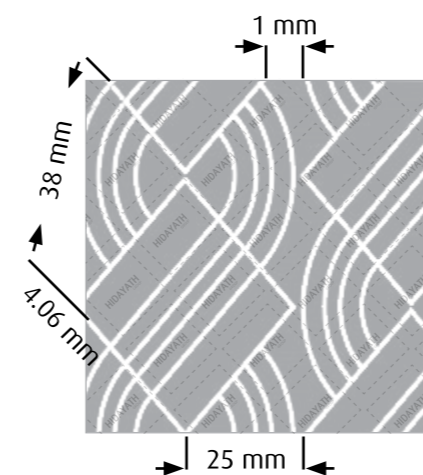

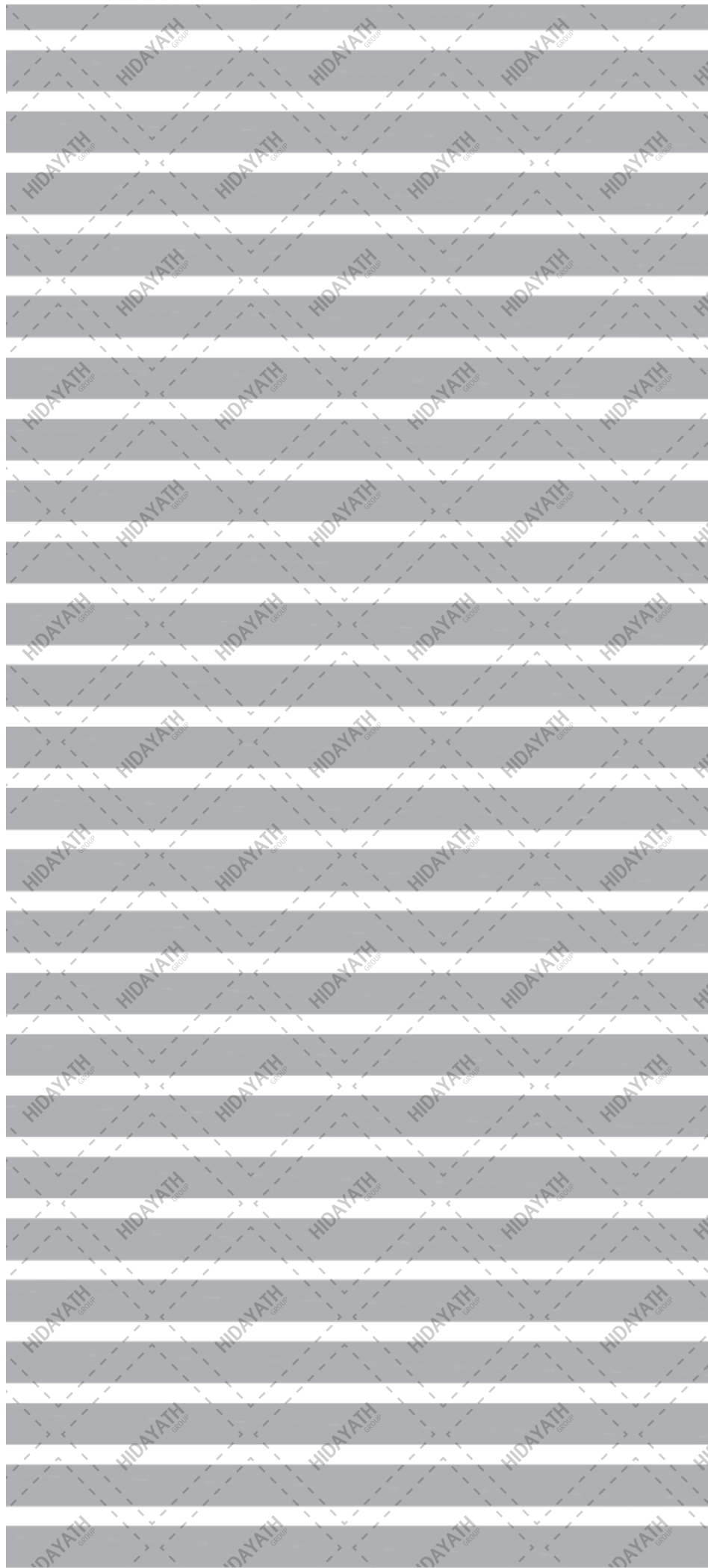

CODE
HTC 1078

Full sheet pattern orientation
white areas are etched.
Maximum Size: 8ft. x 4ft. (Etching)

Different finishes and colours are
available on request.

Designs may be Waterjet cut or
Laser cut as per requirement.
Some designs may come with
borders.

For detailed information kindly
consult our sales personnel.

Note: The displayed illustration is
for orientation only. Actual pattern
may vary from the pattern shown.

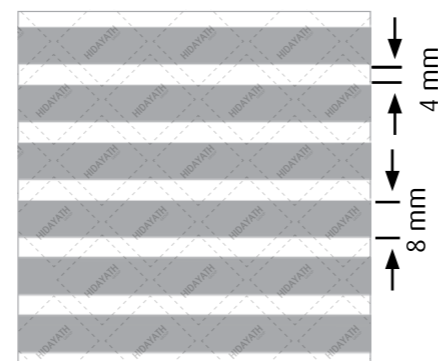

CODE
HTC 1079

Full sheet pattern orientation -
white areas are etched.
Maximum Size: 8ft. x 4ft. (Etching)

Different finishes and colours are
available on request.

Designs may be Waterjet cut or
Laser cut as per requirement.
Some designs may come with
borders.

For detailed information kindly
consult our sales personnel.

Note: The displayed illustration is
for orientation only. Actual pattern
may vary from the pattern shown.

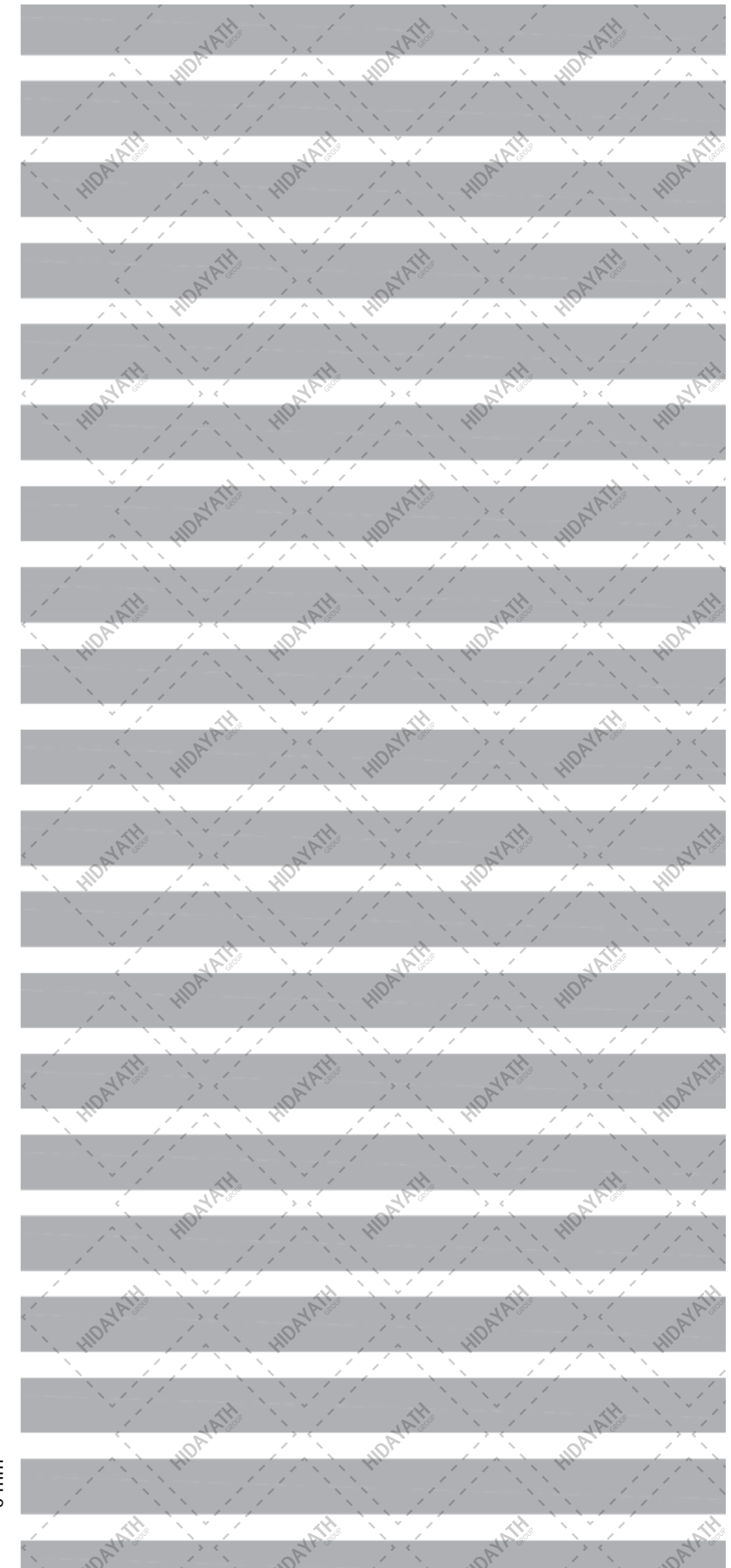
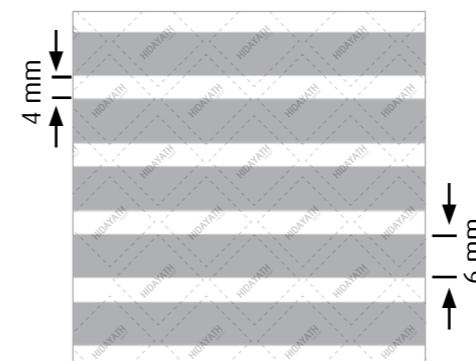



CODE
HTC 1080

Full sheet pattern orientation
white areas are etched.
Maximum Size: 8ft. x 4ft. (Etching)

Different finishes and colours are available on request.

Designs may be Waterjet cut or Laser cut as per requirement. Some designs may come with borders.

For detailed information kindly consult our sales personnel.

Note: The displayed illustration is for orientation only. Actual pattern may vary from the pattern shown.

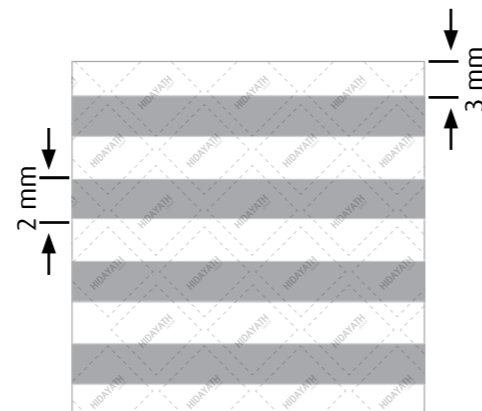

CODE
HTC 1081

Full sheet pattern orientation -
white areas are etched.
Maximum Size: 8ft. x 4ft. (Etching)

Different finishes and colours are available on request.

Designs may be Waterjet cut or Laser cut as per requirement. Some designs may come with borders.

For detailed information kindly consult our sales personnel.

Note: The displayed illustration is for orientation only. Actual pattern may vary from the pattern shown.

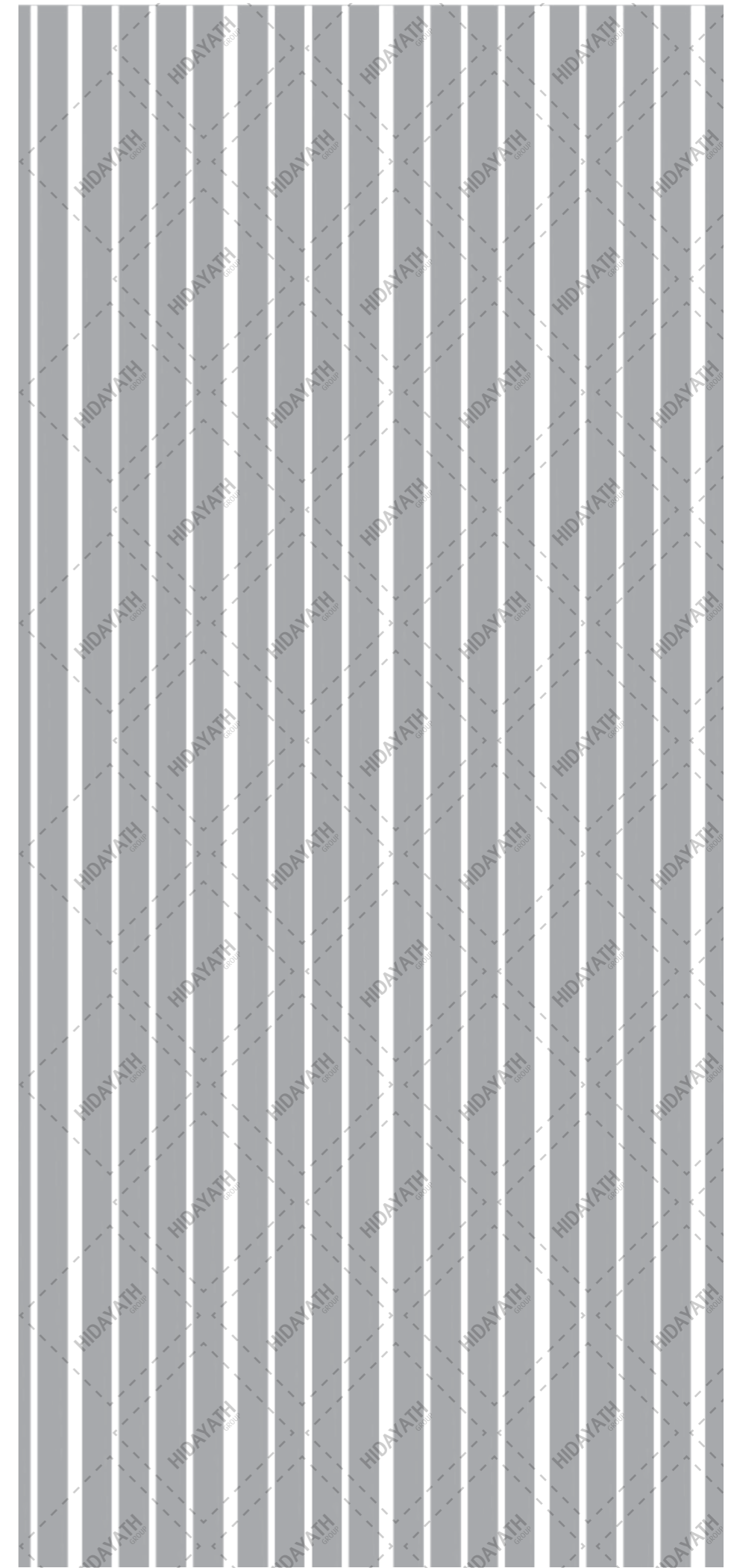
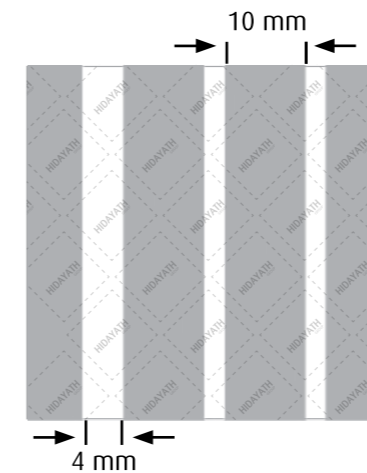



CODE
HTC 1082

Full sheet pattern orientation - **white** areas are etched.
Maximum Size: 8ft. x 4ft. (Etching)

Different finishes and colours are available on request.

Designs may be Waterjet cut or Laser cut as per requirement. Some designs may come with borders.

For detailed information kindly consult our sales personnel.

Note: The displayed illustration is for orientation only. Actual pattern may vary from the pattern shown.

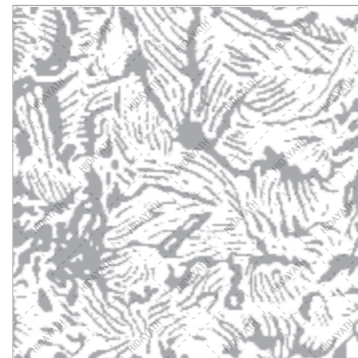

CODE
HTC 1083

Full sheet pattern orientation - **white** areas are etched.
Maximum Size: 8ft. x 4ft. (Etching)

Different finishes and colours are available on request.

Designs may be Waterjet cut or Laser cut as per requirement. Some designs may come with borders.

For detailed information kindly consult our sales personnel.

Note: The displayed illustration is for orientation only. Actual pattern may vary from the pattern shown.

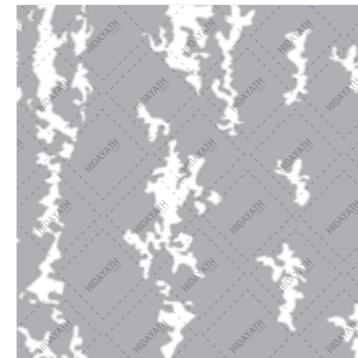

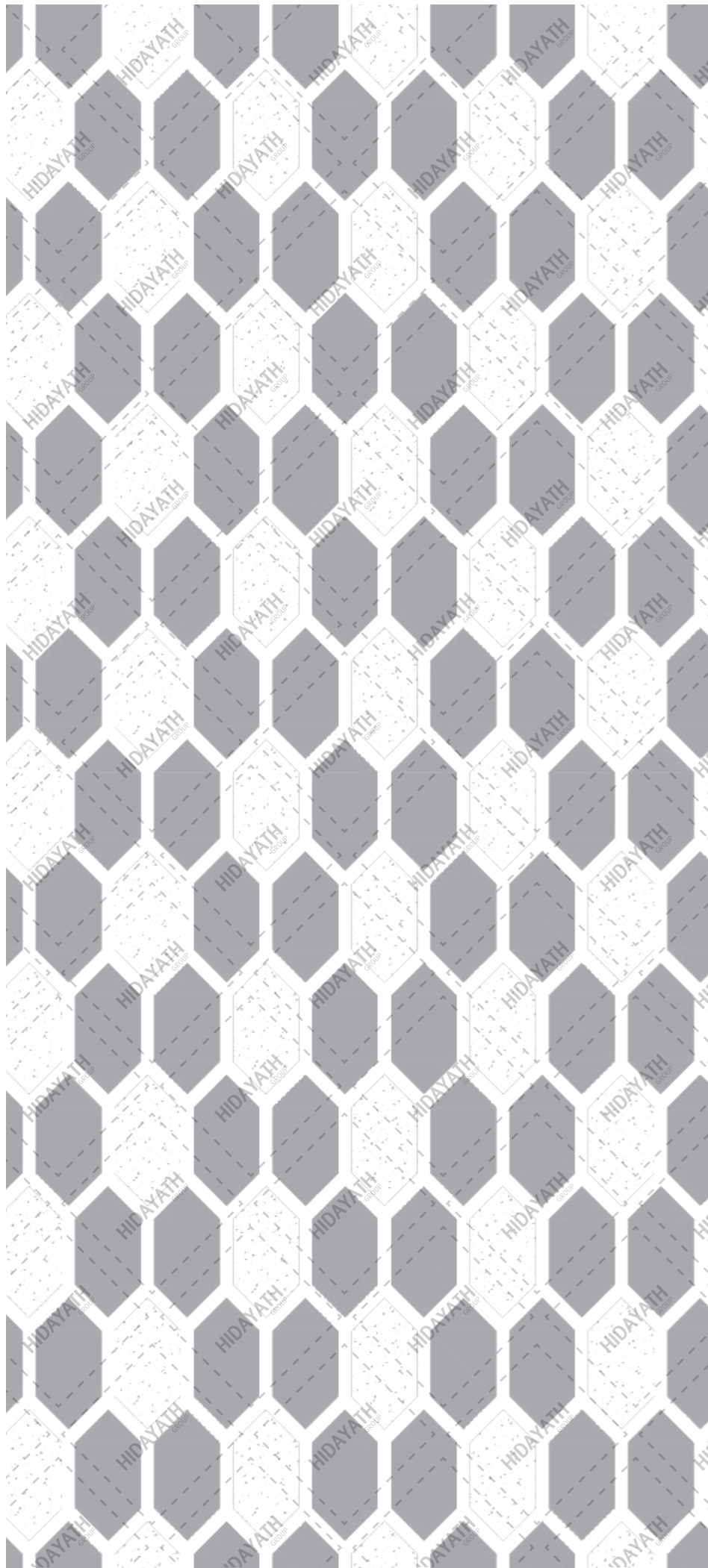

CODE
HTC 1086

Full sheet pattern orientation
white areas are etched.
Maximum Size: 8ft. x 4ft. (Etching)

Different finishes and colours are available on request.

Designs may be Waterjet cut or Laser cut as per requirement. Some designs may come with borders.

For detailed information kindly consult our sales personnel.

Note: The displayed illustration is for orientation only. Actual pattern may vary from the pattern shown.

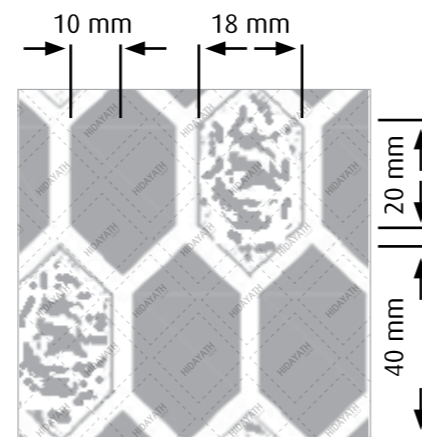

CODE
HTC 1087

Full sheet pattern orientation -
white areas are etched.
Maximum Size: 8ft. x 4ft. (Etching)

Different finishes and colours are available on request.

Designs may be Waterjet cut or Laser cut as per requirement. Some designs may come with borders.

For detailed information kindly consult our sales personnel.

Note: The displayed illustration is for orientation only. Actual pattern may vary from the pattern shown.

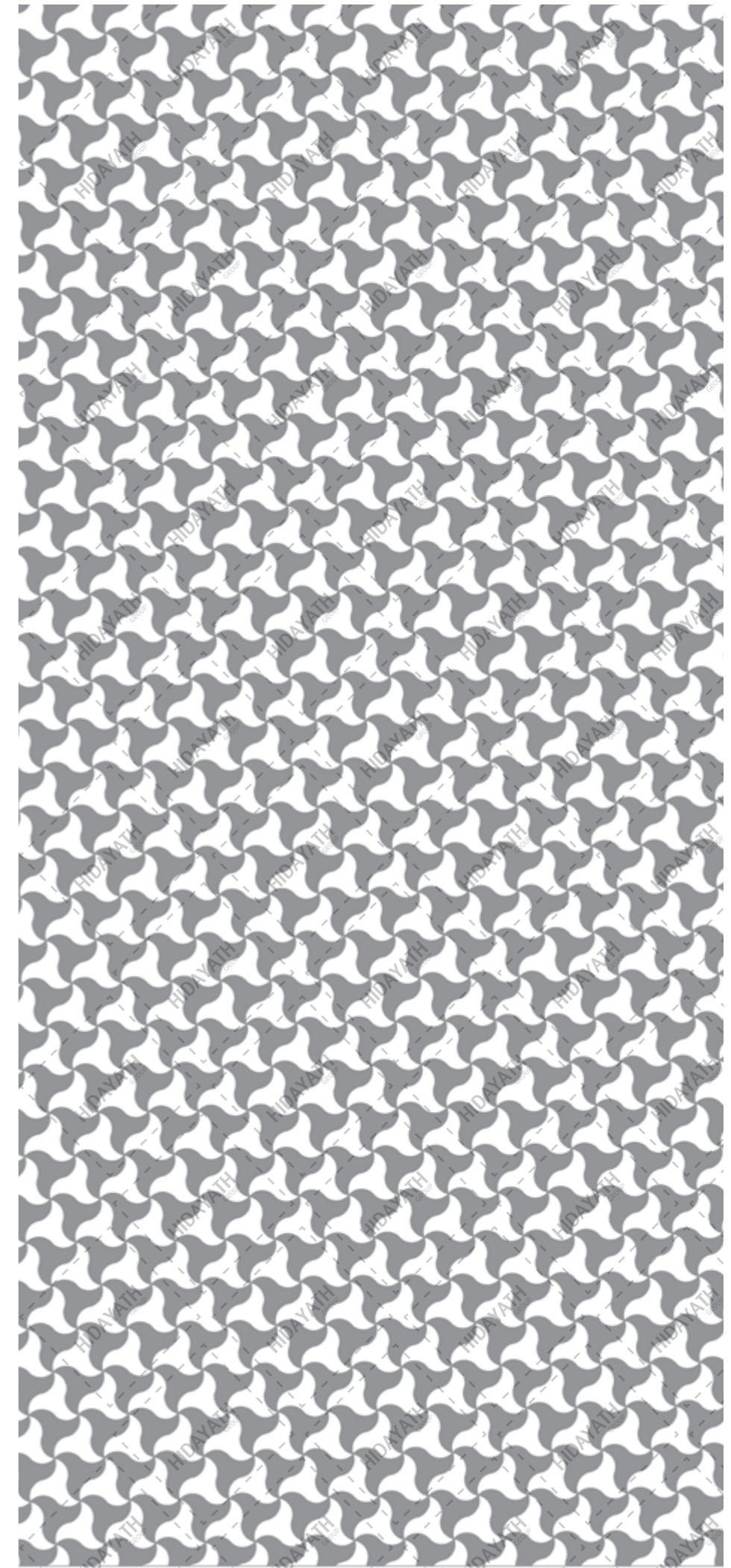
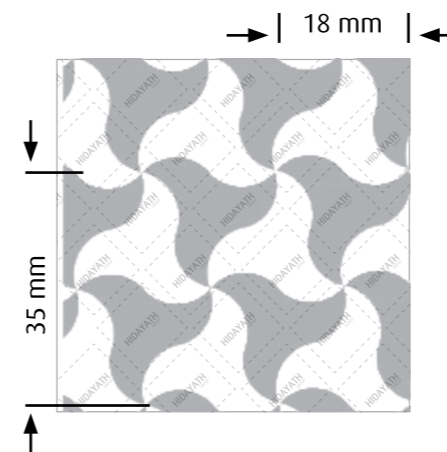

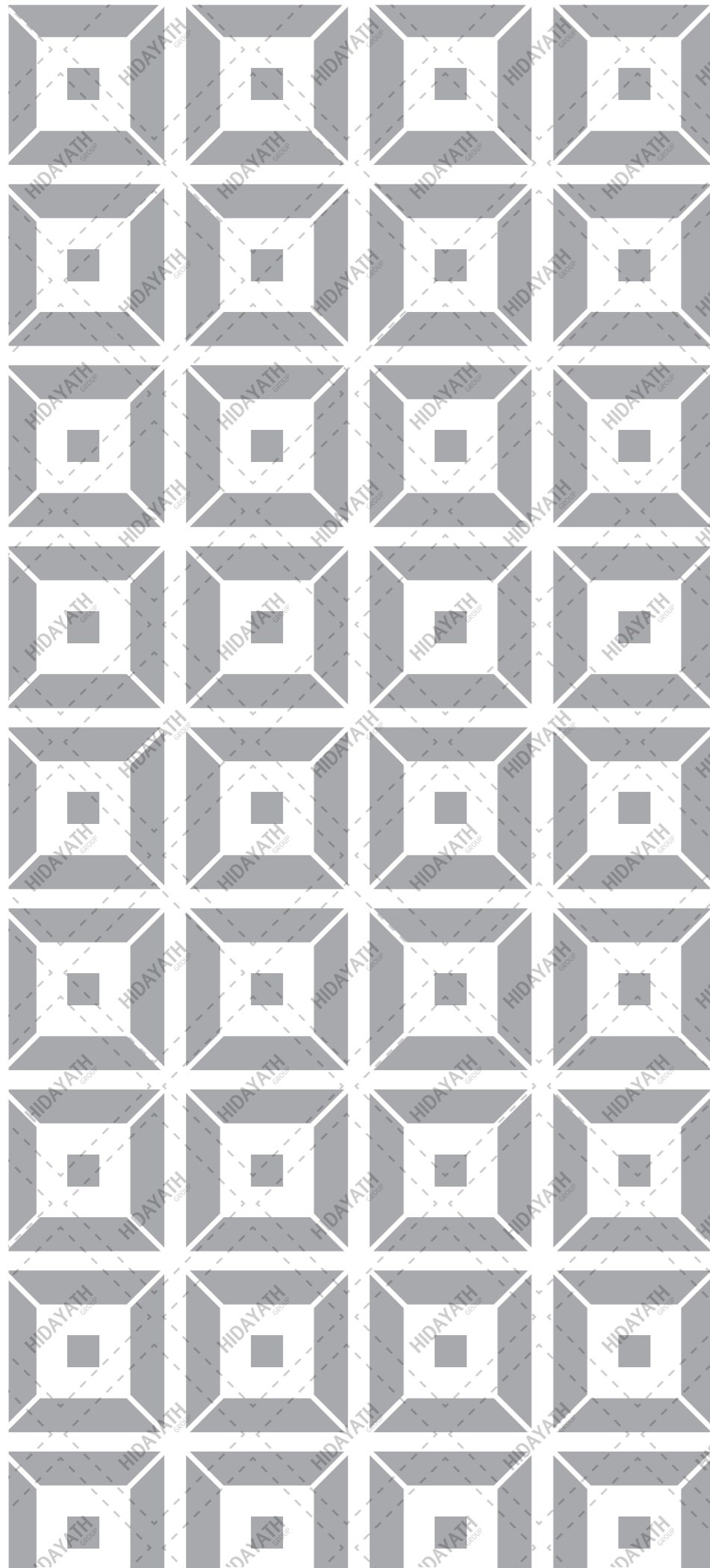

CODE
HTC 1089

Full sheet pattern orientation
white areas are etched.
Maximum Size: 8ft. x 4ft. (Etching)

Different finishes and colours are available on request.

Designs may be Waterjet cut or Laser cut as per requirement. Some designs may come with borders.

For detailed information kindly consult our sales personnel.

Note: The displayed illustration is for orientation only. Actual pattern may vary from the pattern shown.

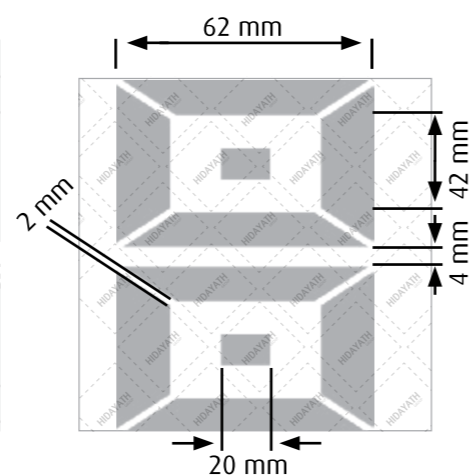

CODE
HTC 1091

Full sheet pattern orientation -
white areas are etched.
Maximum Size: 8ft. x 4ft. (Etching)

Different finishes and colours are available on request.

Designs may be Waterjet cut or Laser cut as per requirement. Some designs may come with borders.

For detailed information kindly consult our sales personnel.

Note: The displayed illustration is for orientation only. Actual pattern may vary from the pattern shown.

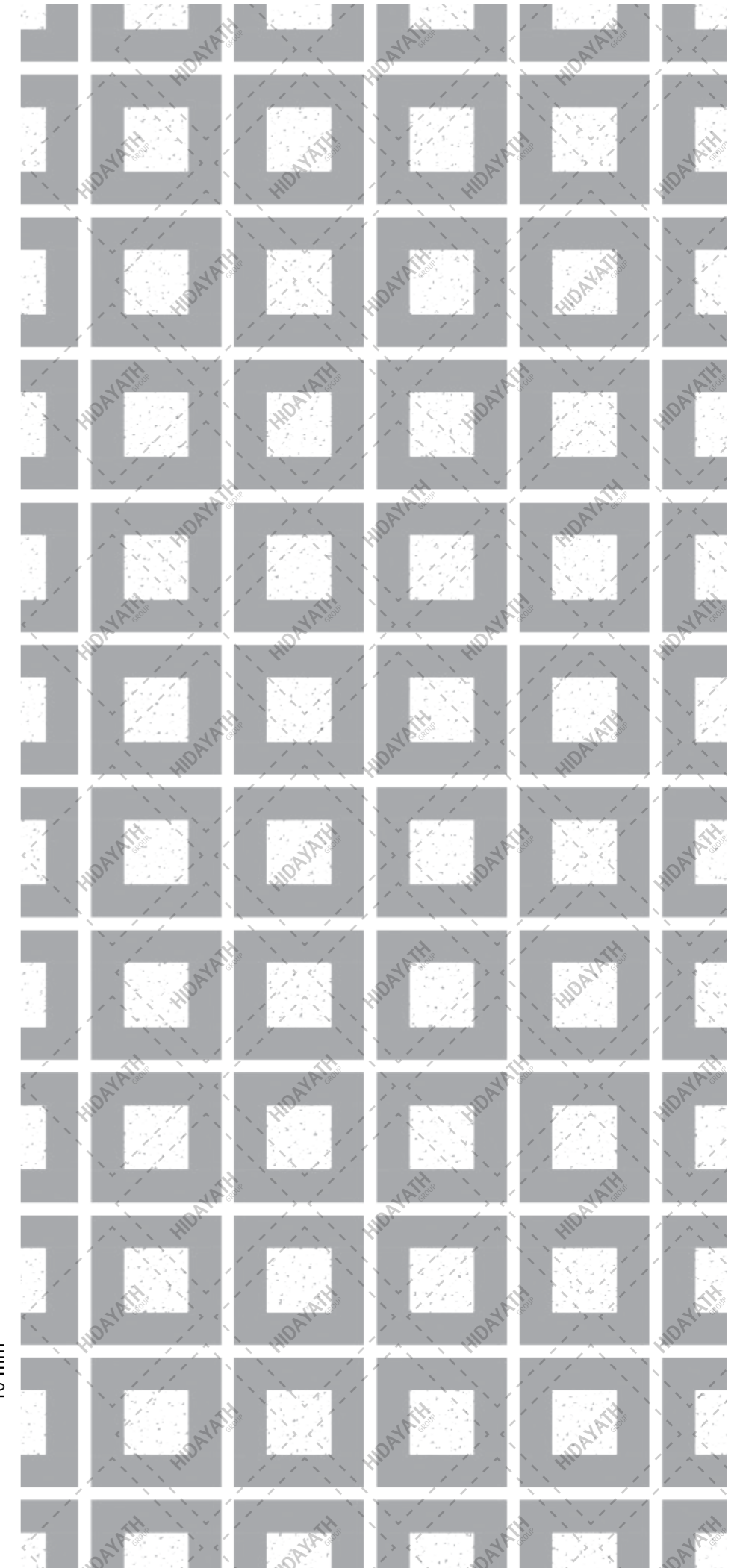
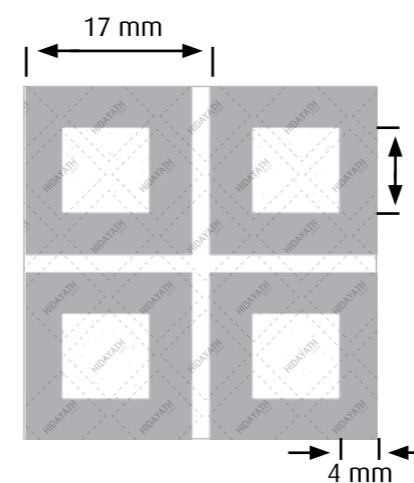

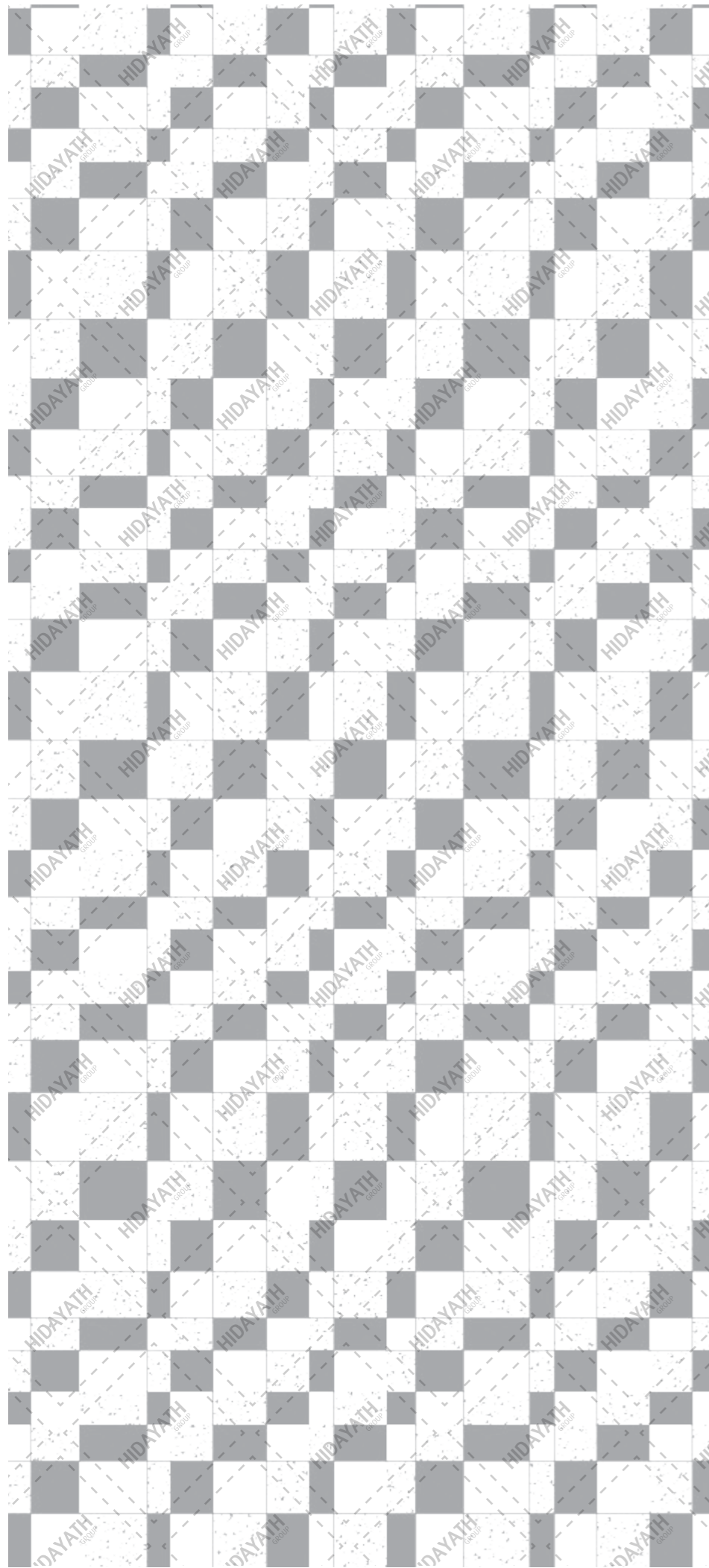

CODE
HTC 1092

Full sheet pattern orientation
white areas are etched.
Maximum Size: 8ft. x 4ft. (Etching)

Different finishes and colours are available on request.

Designs may be Waterjet cut or Laser cut as per requirement. Some designs may come with borders.

For detailed information kindly consult our sales personnel.

Note: The displayed illustration is for orientation only. Actual pattern may vary from the pattern shown.

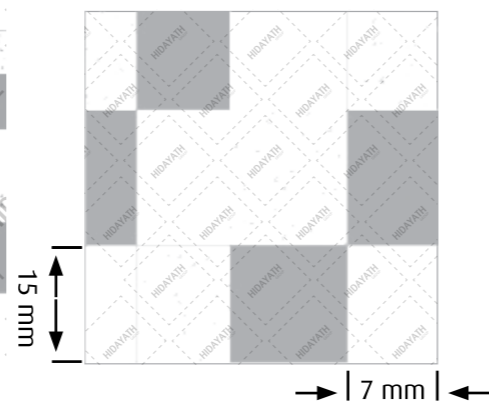

CODE
HTC 1093

Full sheet pattern orientation -
white areas are etched.
Maximum Size: 8ft. x 4ft. (Etching)

Different finishes and colours are available on request.

Designs may be Waterjet cut or Laser cut as per requirement. Some designs may come with borders.

For detailed information kindly consult our sales personnel.

Note: The displayed illustration is for orientation only. Actual pattern may vary from the pattern shown.

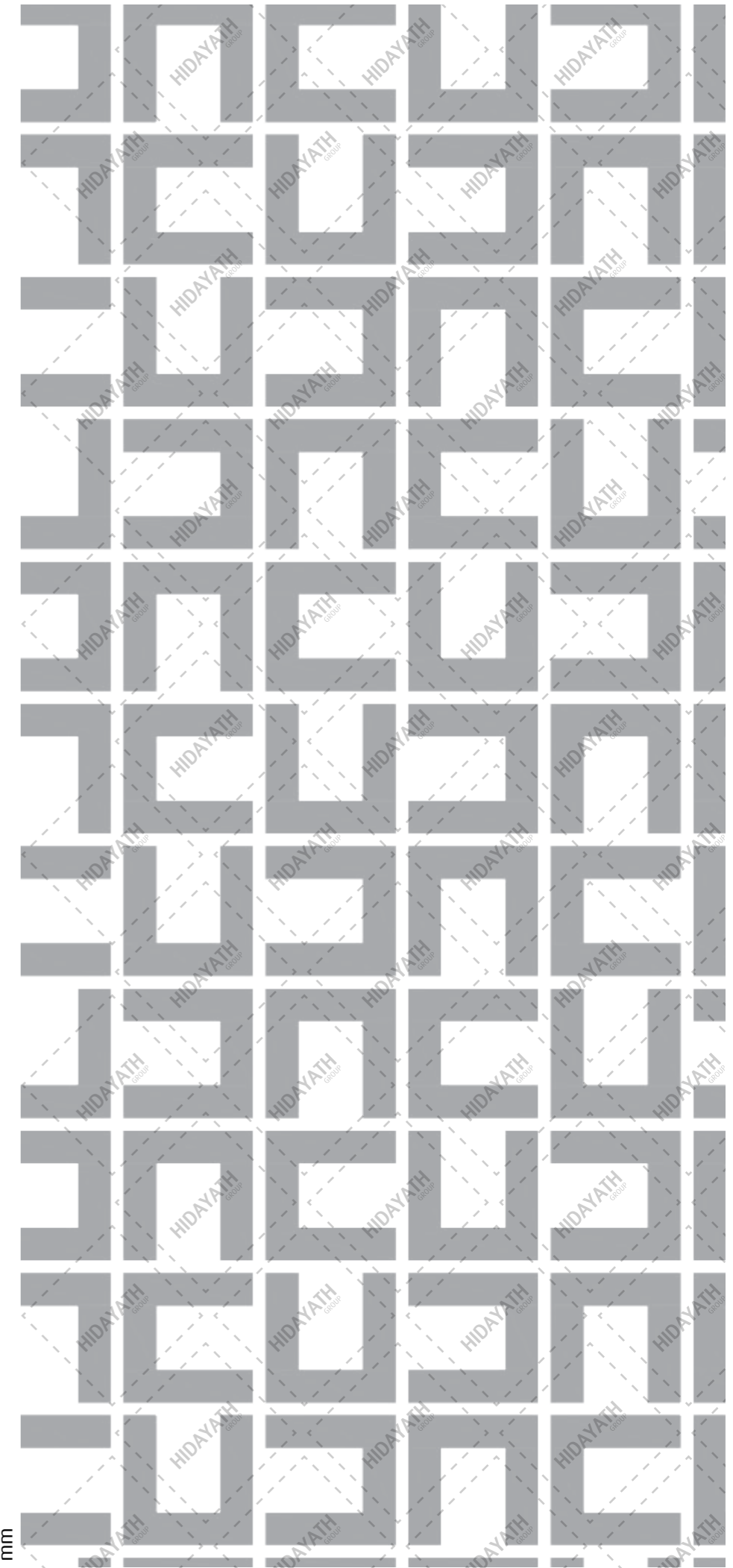
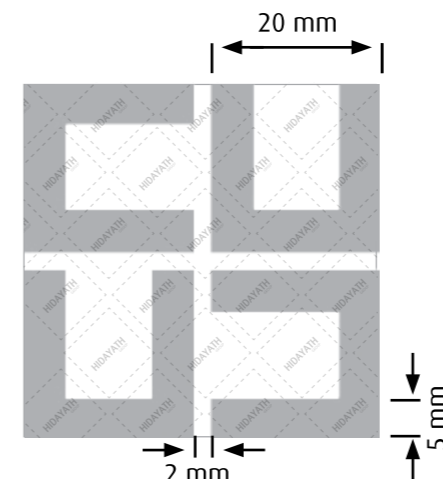

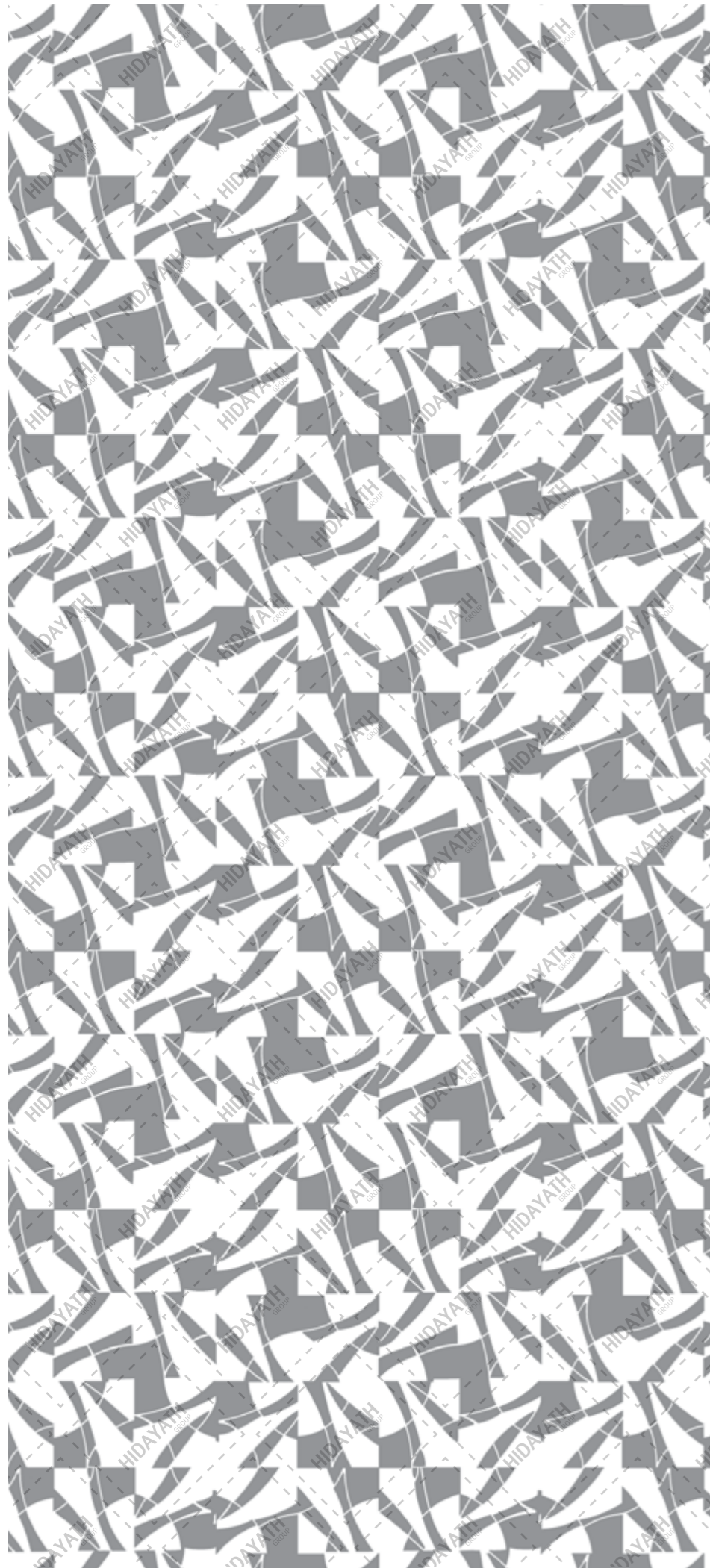

CODE
HTC 1094

Full sheet pattern orientation - **white** areas are etched.
Maximum Size: 8ft. x 4ft. (Etching)

Different finishes and colours are available on request.

Designs may be Waterjet cut or Laser cut as per requirement. Some designs may come with borders.

For detailed information kindly consult our sales personnel.

Note: The displayed illustration is for orientation only. Actual pattern may vary from the pattern shown.



CODE
HTC 1095

Full sheet pattern orientation - **white** areas are etched.
Maximum Size: 8ft. x 4ft. (Etching)

Different finishes and colours are available on request.

Designs may be Waterjet cut or Laser cut as per requirement. Some designs may come with borders.

For detailed information kindly consult our sales personnel.

Note: The displayed illustration is for orientation only. Actual pattern may vary from the pattern shown.

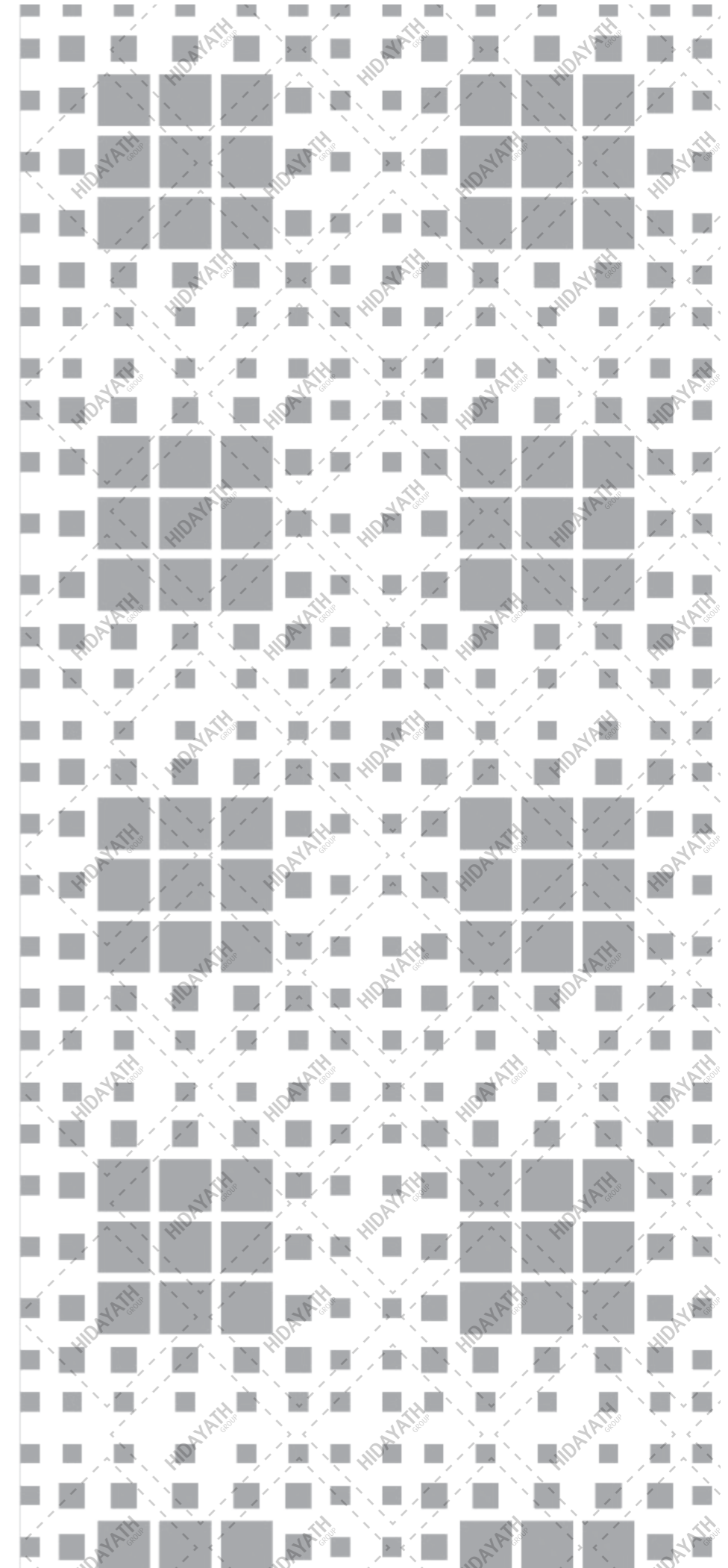
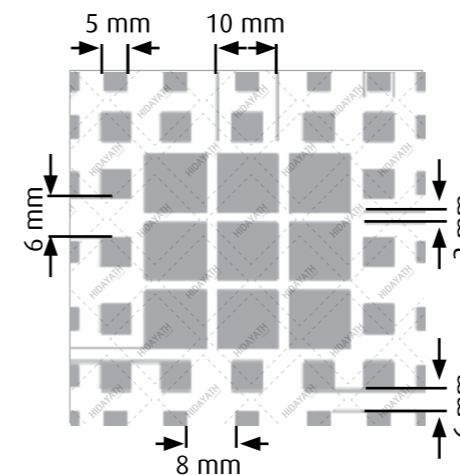

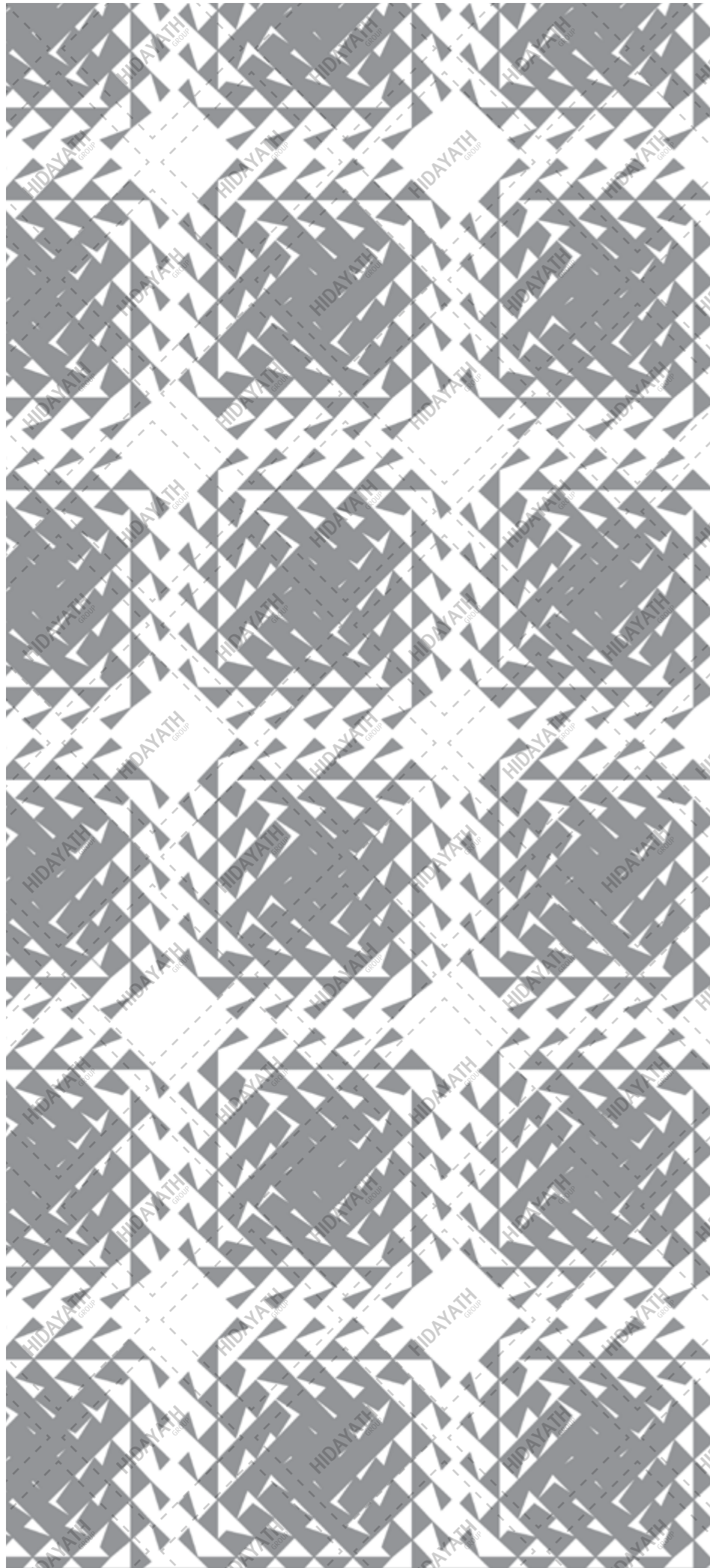

CODE
HTC 1096

Full sheet pattern orientation - **white** areas are etched.
Maximum Size: 8ft. x 4ft. (Etching)

Different finishes and colours are available on request.

Designs may be Waterjet cut or Laser cut as per requirement. Some designs may come with borders.

For detailed information kindly consult our sales personnel.

Note: The displayed illustration is for orientation only. Actual pattern may vary from the pattern shown.

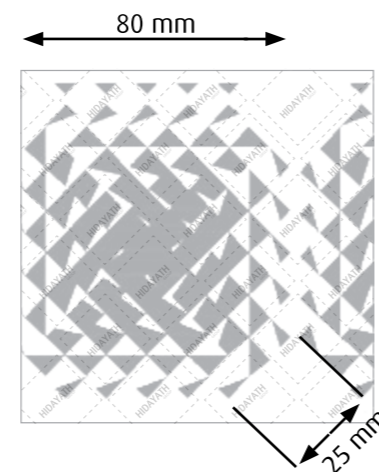

CODE
HTC 1097

Full sheet pattern orientation - **white** areas are etched.
Maximum Size: 8ft. x 4ft. (Etching)

Different finishes and colours are available on request.

Designs may be Waterjet cut or Laser cut as per requirement. Some designs may come with borders.

For detailed information kindly consult our sales personnel.

Note: The displayed illustration is for orientation only. Actual pattern may vary from the pattern shown.

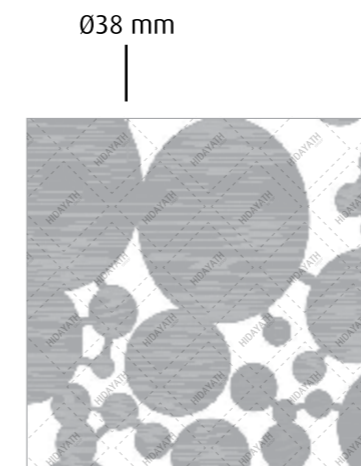

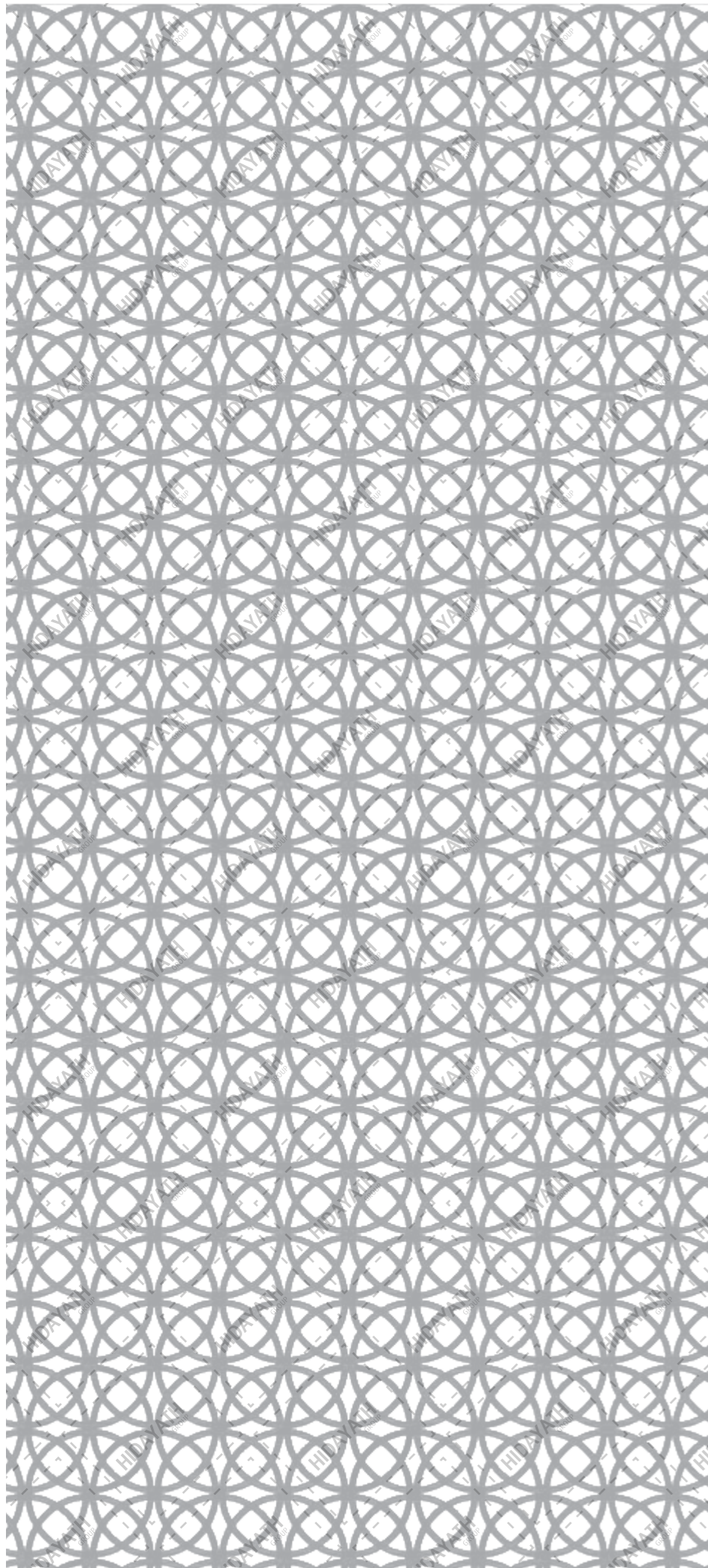

CODE
HTC 1098

Full sheet pattern orientation - **white** areas are etched.
Maximum Size: 8ft. x 4ft. (Etching)

Different finishes and colours are available on request.

Designs may be Waterjet cut or Laser cut as per requirement. Some designs may come with borders.

For detailed information kindly consult our sales personnel.

Note: The displayed illustration is for orientation only. Actual pattern may vary from the pattern shown.

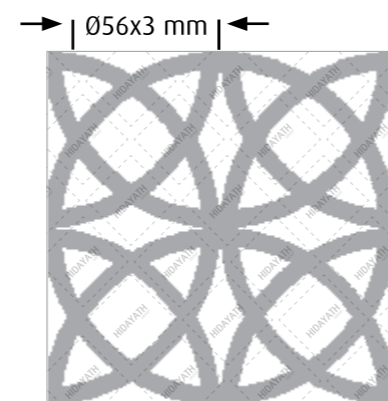

CODE
HTC 1100

Full sheet pattern orientation - **white** areas are etched.
Maximum Size: 8ft. x 4ft. (Etching)

Different finishes and colours are available on request.

Designs may be Waterjet cut or Laser cut as per requirement. Some designs may come with borders.

For detailed information kindly consult our sales personnel.

Note: The displayed illustration is for orientation only. Actual pattern may vary from the pattern shown.

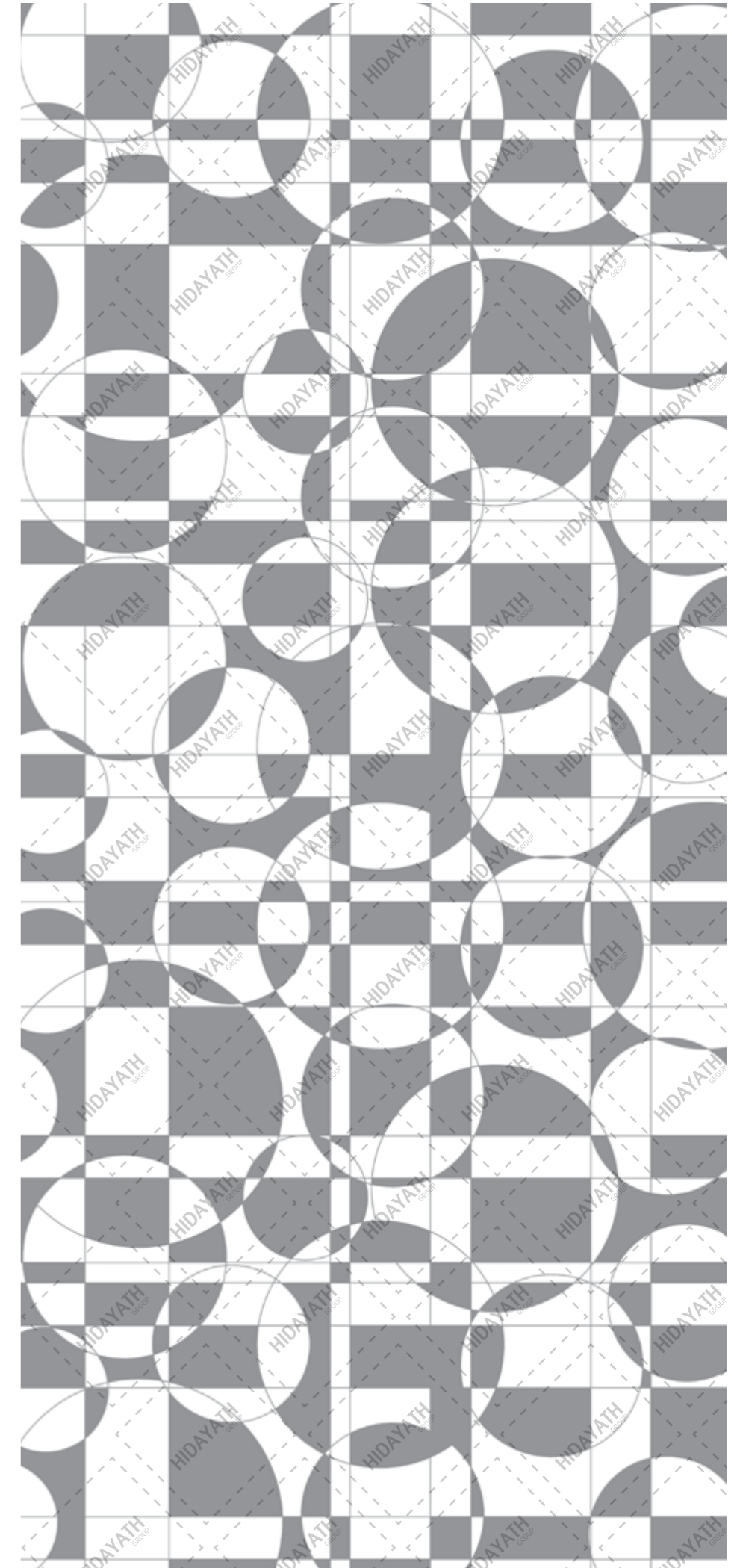
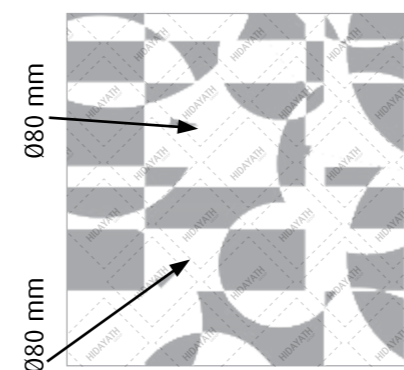

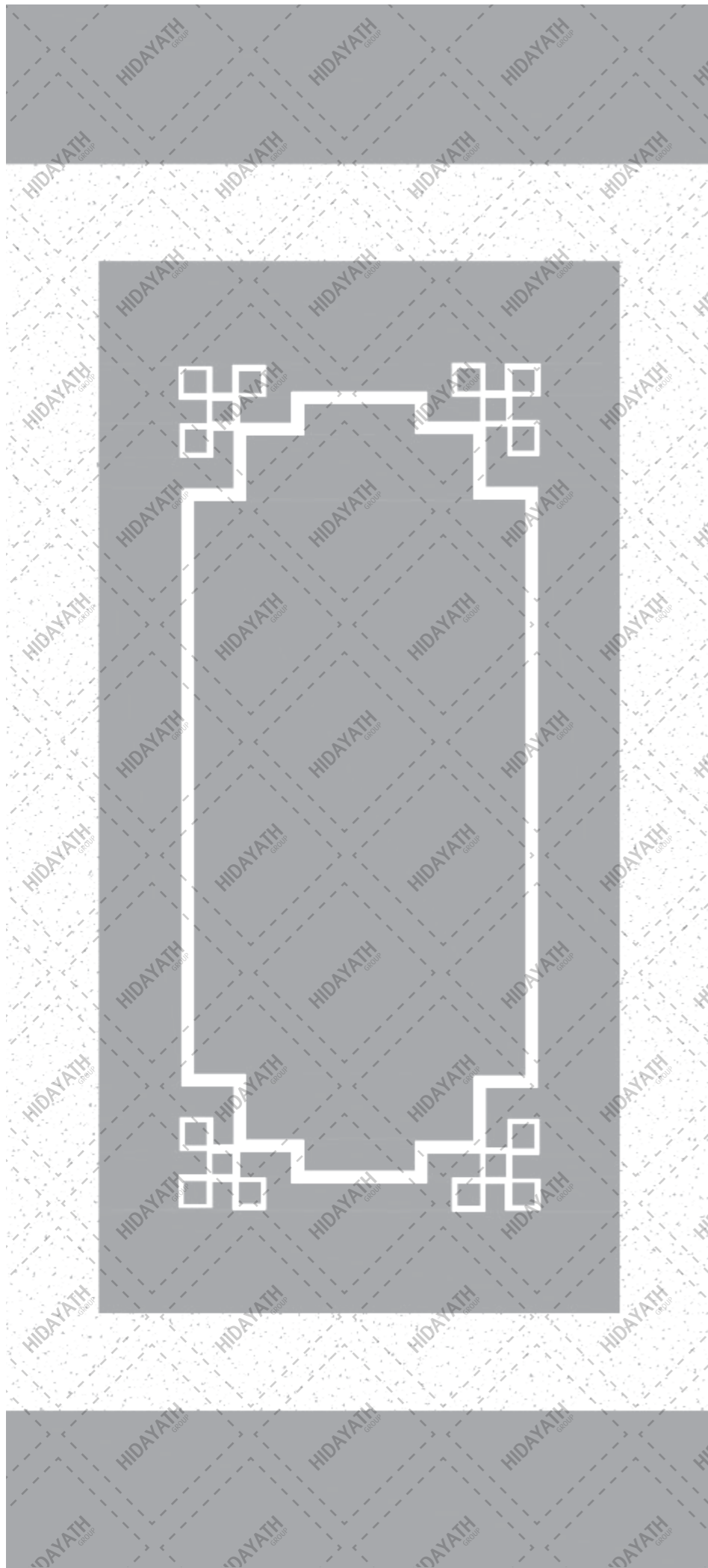

CODE
HTC 1102

Full sheet pattern orientation - **white** areas are etched.
Maximum Size: 8ft. x 4ft. (Etching)

Different finishes and colours are available on request.

Designs may be Waterjet cut or Laser cut as per requirement. Some designs may come with borders.

For detailed information kindly consult our sales personnel.

Note: The displayed illustration is for orientation only. Actual pattern may vary from the pattern shown.

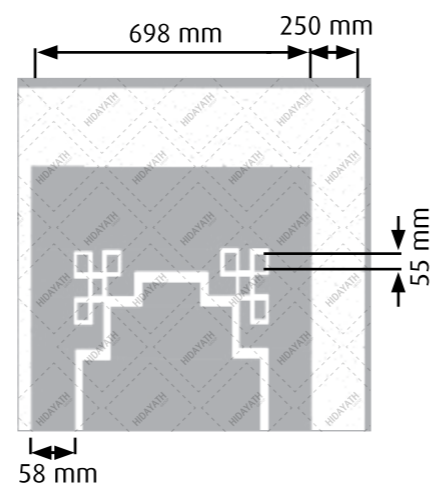

CODE
HTC 1103

Full sheet pattern orientation - **white** areas are etched.
Maximum Size: 8ft. x 4ft. (Etching)

Different finishes and colours are available on request.

Designs may be Waterjet cut or Laser cut as per requirement. Some designs may come with borders.

For detailed information kindly consult our sales personnel.

Note: The displayed illustration is for orientation only. Actual pattern may vary from the pattern shown.

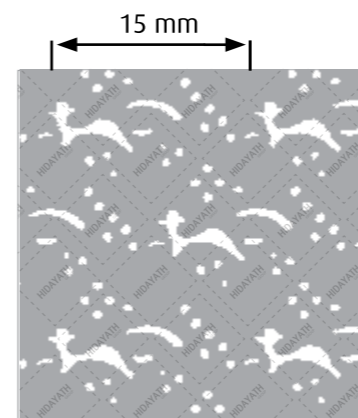

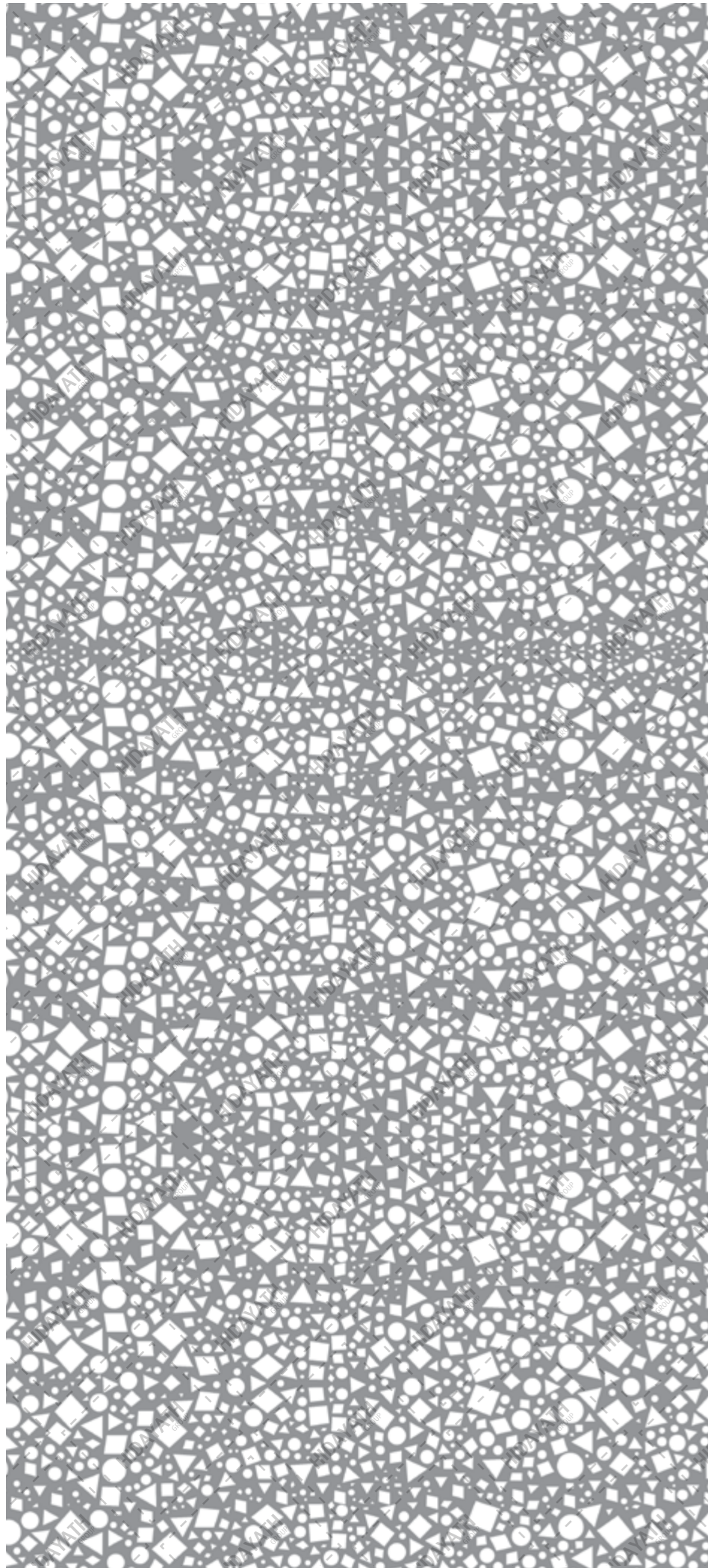

CODE
HTC 1104

Full sheet pattern orientation - **white** areas are etched.
Maximum Size: 8ft. x 4ft. (Etching)

Different finishes and colours are available on request.

Designs may be Waterjet cut or Laser cut as per requirement. Some designs may come with borders.

For detailed information kindly consult our sales personnel.

Note: The displayed illustration is for orientation only. Actual pattern may vary from the pattern shown.

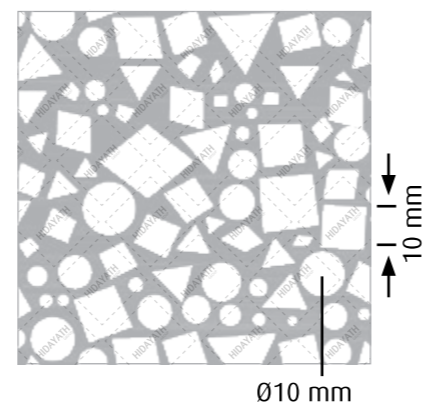

CODE
HTC 1105

Full sheet pattern orientation - **white** areas are etched.
Maximum Size: 8ft. x 4ft. (Etching)

Different finishes and colours are available on request.

Designs may be Waterjet cut or Laser cut as per requirement. Some designs may come with borders.

For detailed information kindly consult our sales personnel.

Note: The displayed illustration is for orientation only. Actual pattern may vary from the pattern shown.

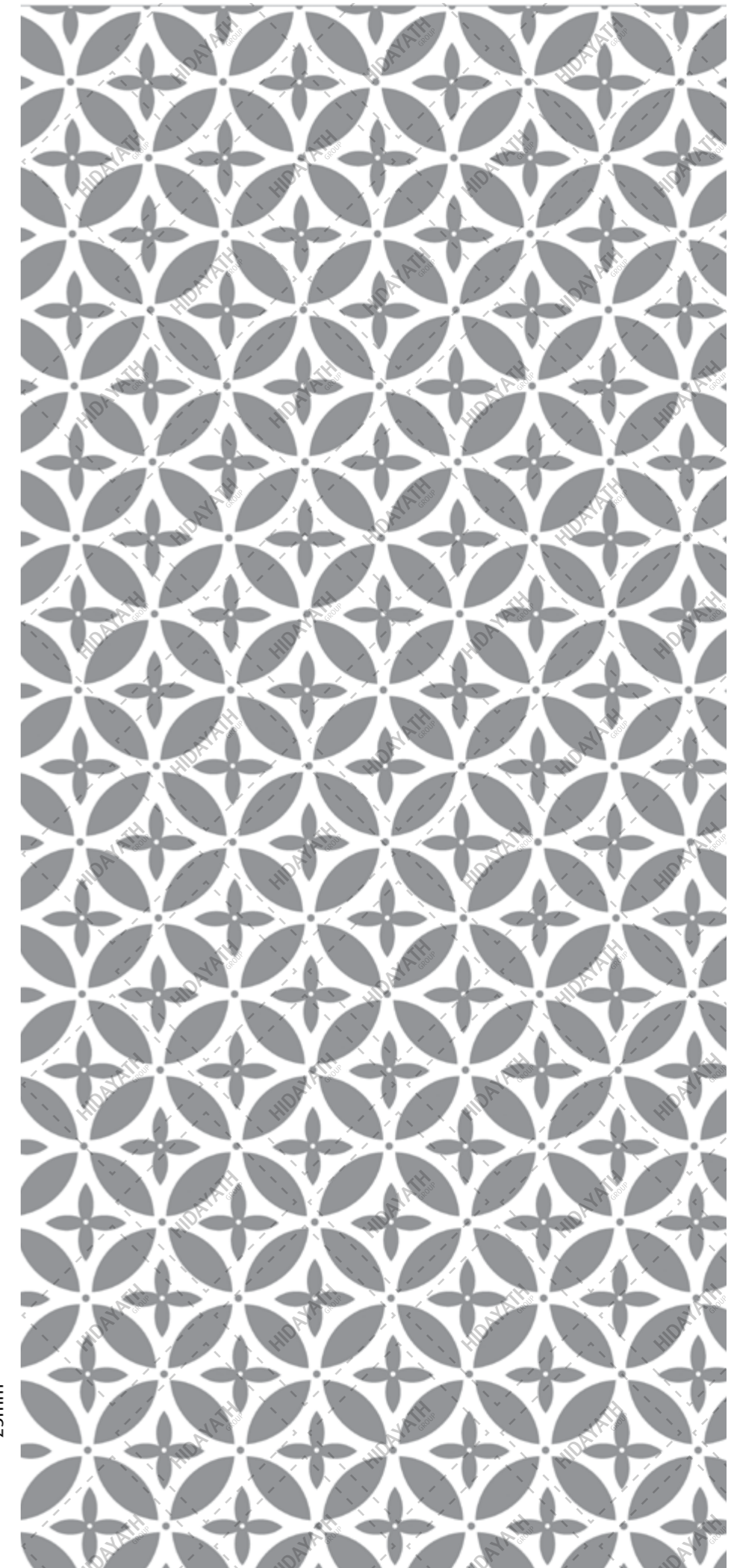
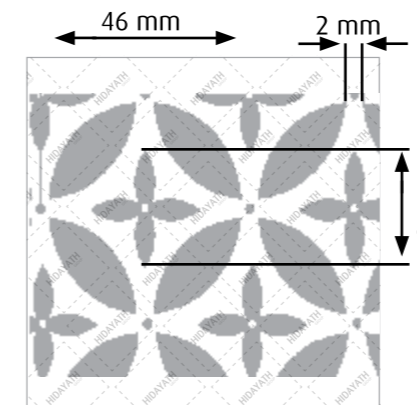

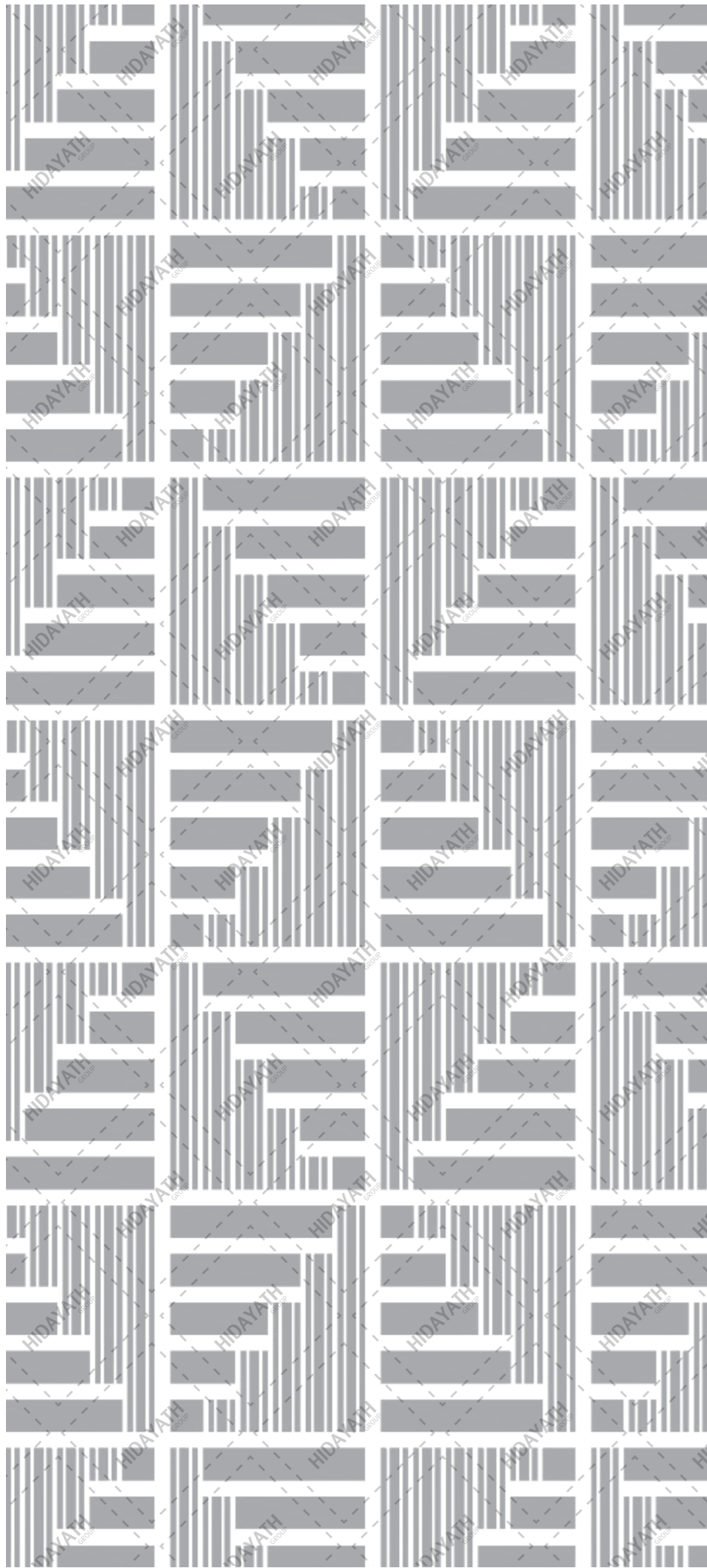

CODE
HTC 1106

Full sheet pattern orientation
white areas are etched.
Maximum Size: 8ft. x 4ft. (Etching)

Different finishes and colours are available on request.

Designs may be Waterjet cut or Laser cut as per requirement. Some designs may come with borders.

For detailed information kindly consult our sales personnel.

Note: The displayed illustration is for orientation only. Actual pattern may vary from the pattern shown.

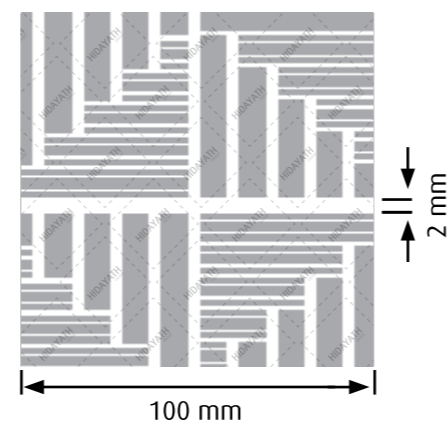

CODE
HTC 1107

Full sheet pattern orientation -
white areas are etched.
Maximum Size: 8ft. x 4ft. (Etching)

Different finishes and colours are available on request.

Designs may be Waterjet cut or Laser cut as per requirement. Some designs may come with borders.

For detailed information kindly consult our sales personnel.

Note: The displayed illustration is for orientation only. Actual pattern may vary from the pattern shown.

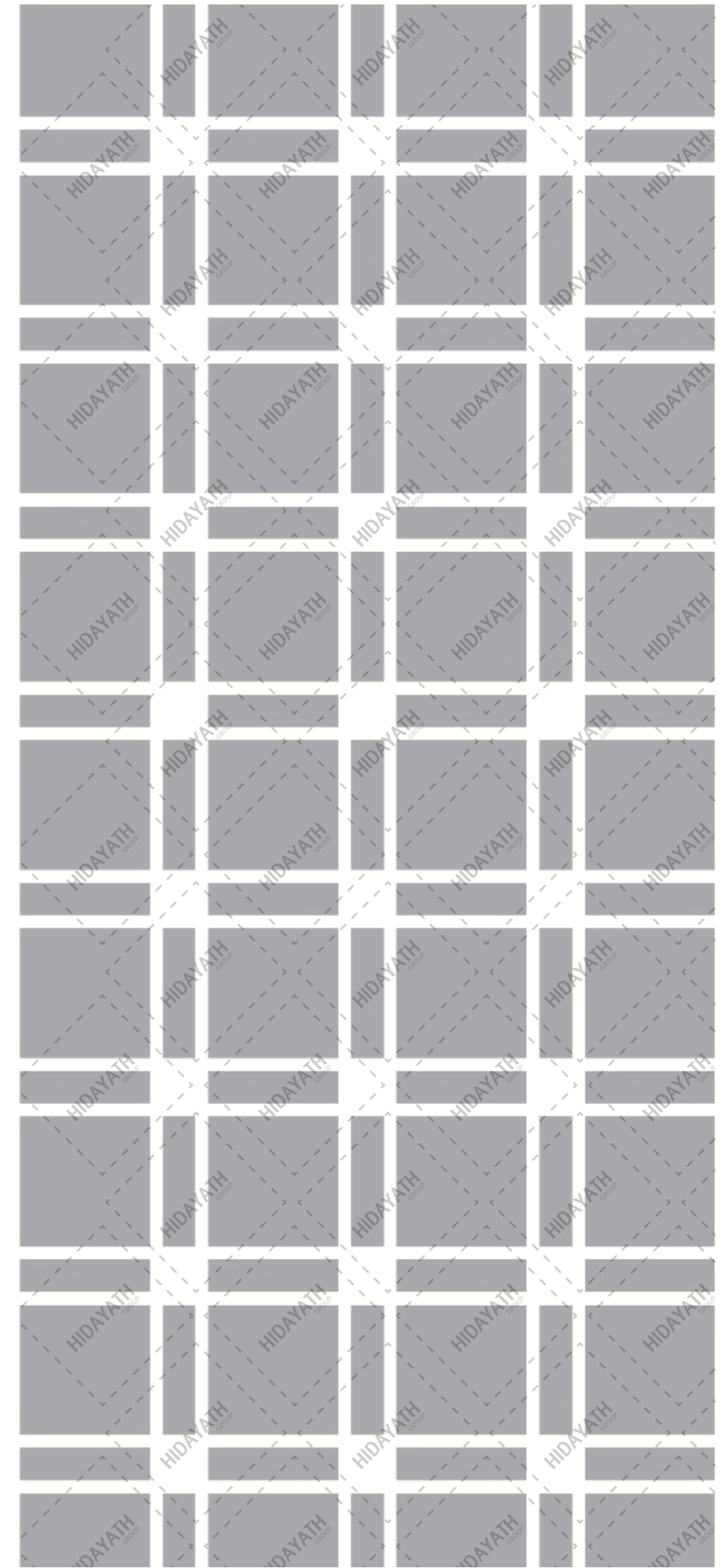
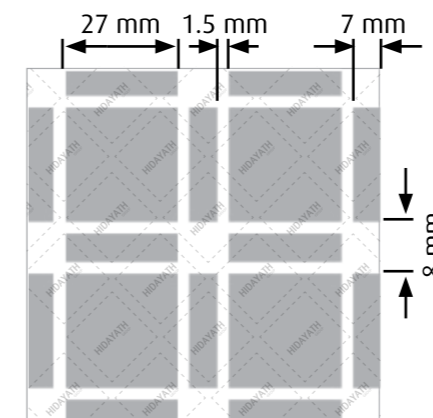

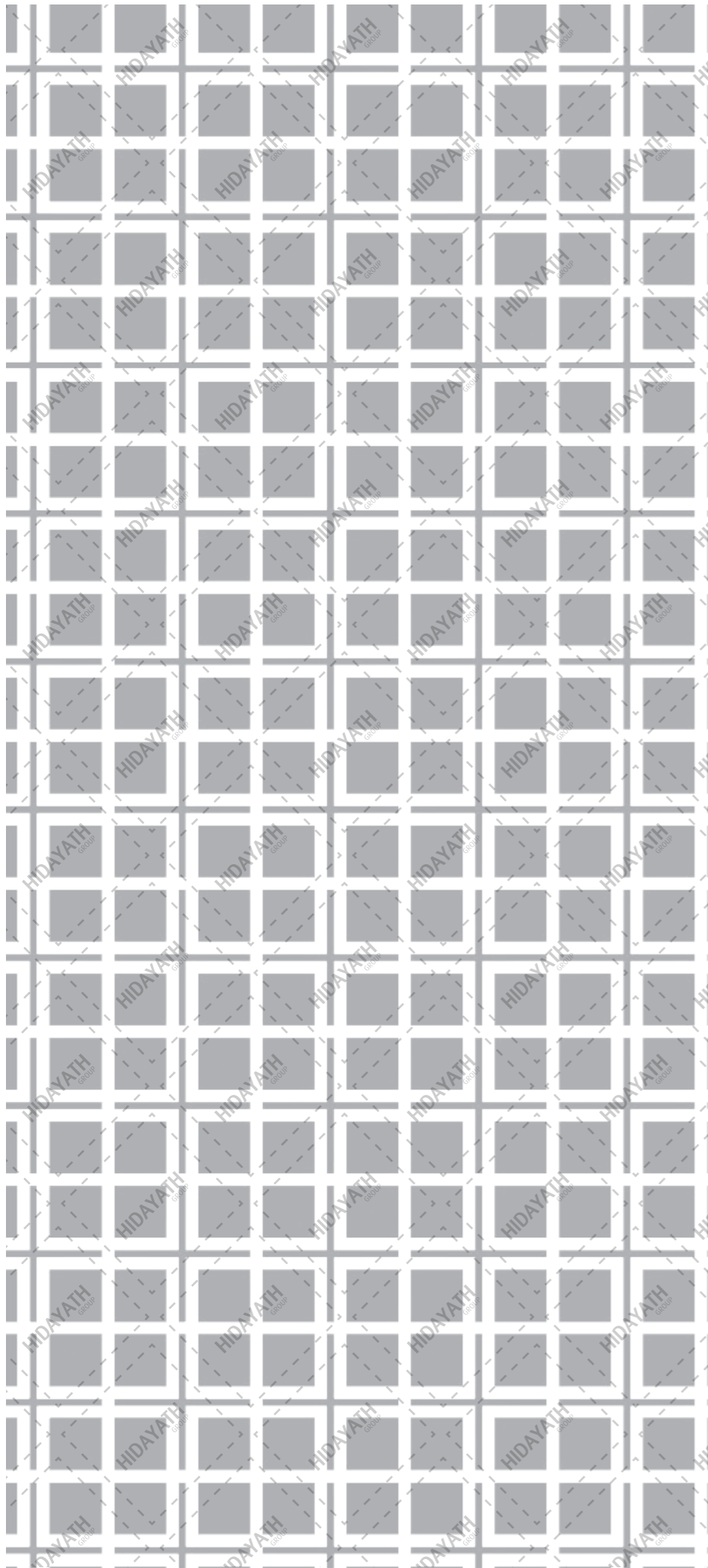

CODE
HTC 1108

Full sheet pattern orientation
white areas are etched.
Maximum Size: 8ft. x 4ft. (Etching)

Different finishes and colours are available on request.

Designs may be Waterjet cut or Laser cut as per requirement. Some designs may come with borders.

For detailed information kindly consult our sales personnel.

Note: The displayed illustration is for orientation only. Actual pattern may vary from the pattern shown.

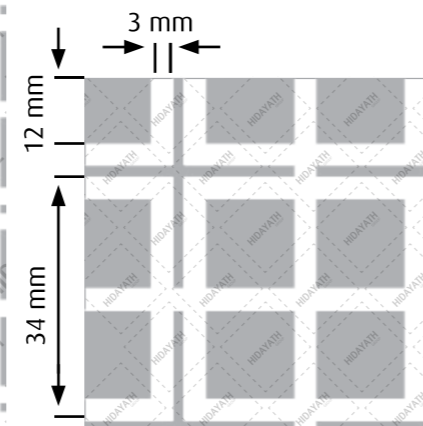

CODE
HTC 1109

Full sheet pattern orientation -
white areas are etched.
Maximum Size: 8ft. x 4ft. (Etching)

Different finishes and colours are available on request.

Designs may be Waterjet cut or Laser cut as per requirement. Some designs may come with borders.

For detailed information kindly consult our sales personnel.

Note: The displayed illustration is for orientation only. Actual pattern may vary from the pattern shown.

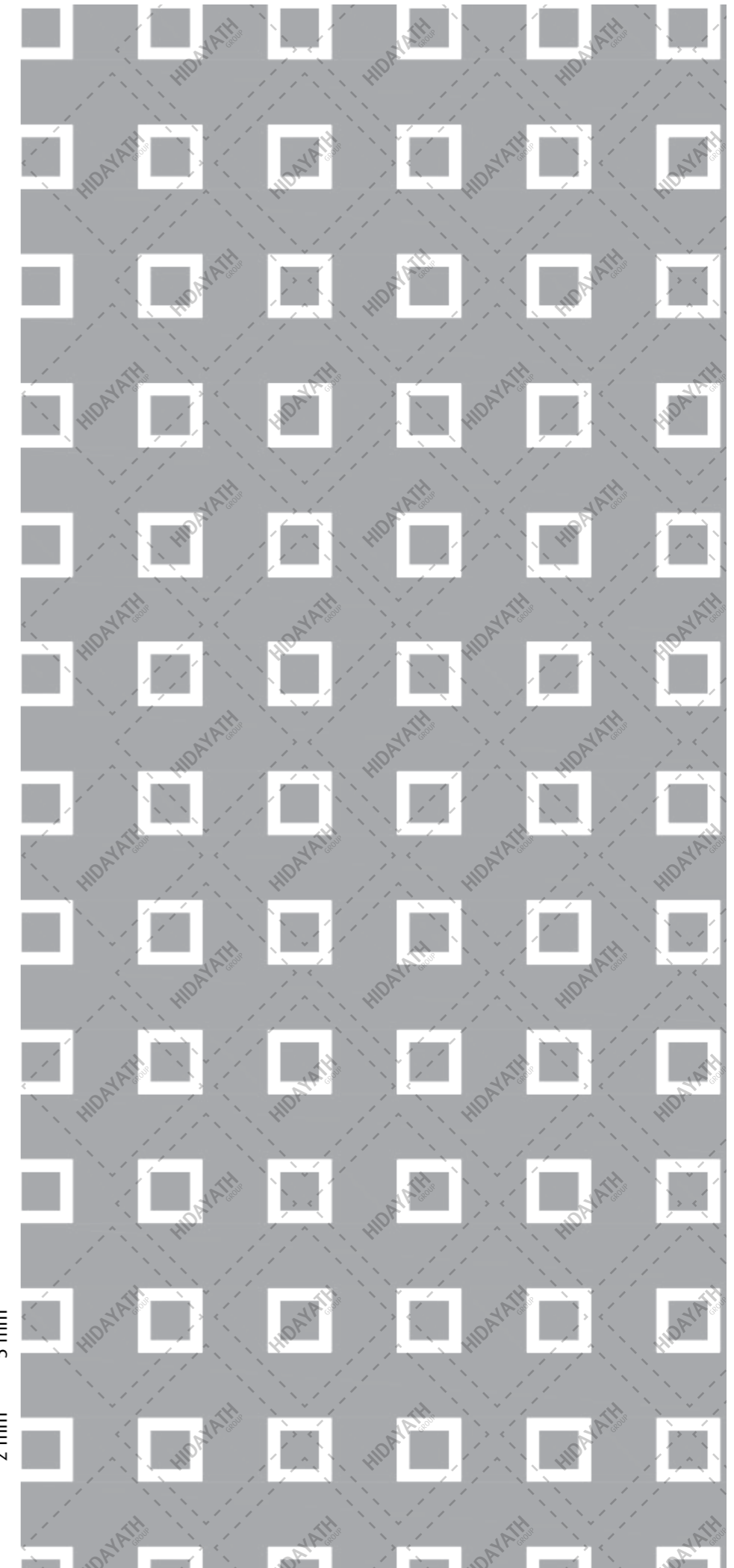
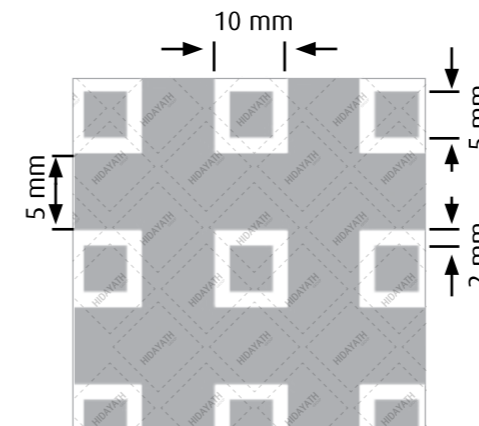

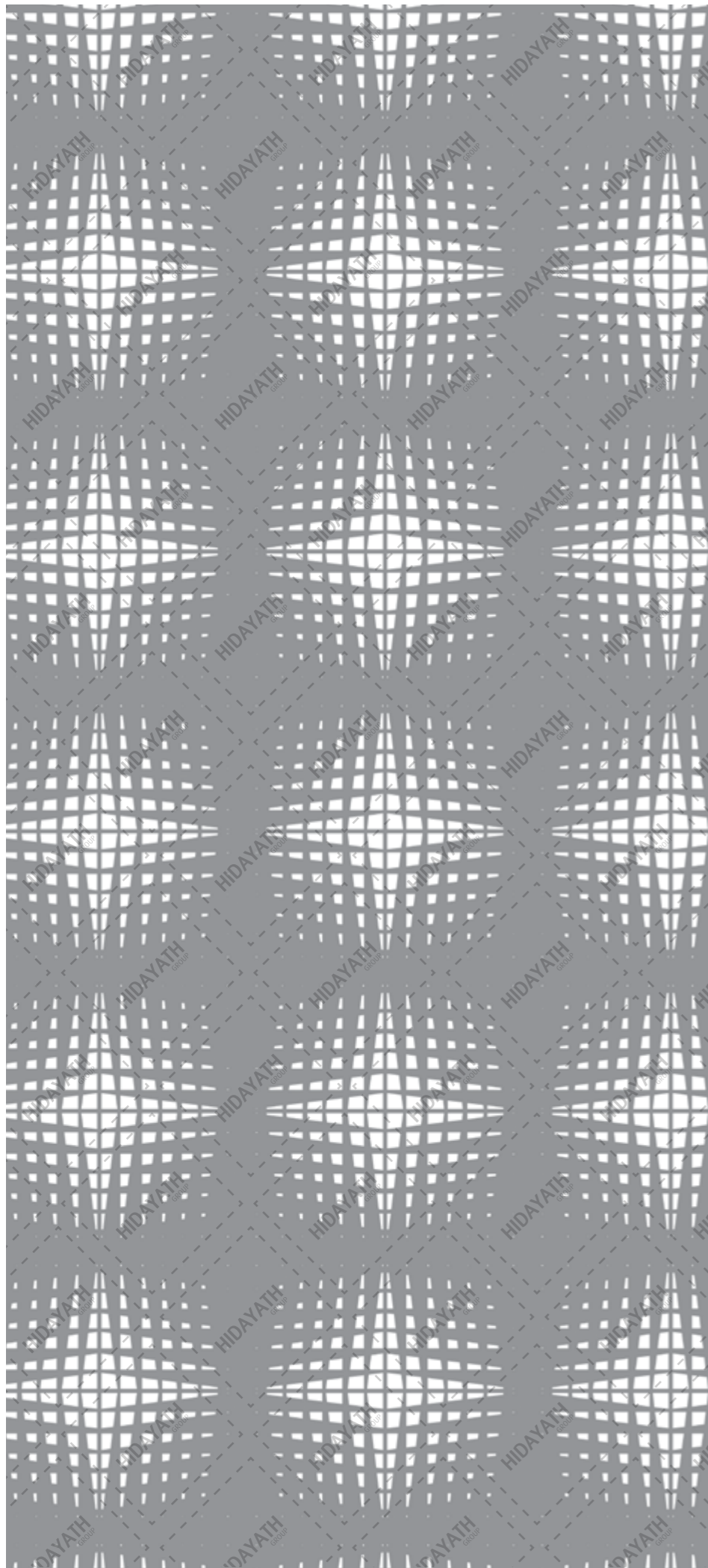

CODE
HTC 1110

Full sheet pattern orientation
white areas are etched.
Maximum Size: 8ft. x 4ft. (Etching)

Different finishes and colours are available on request.

Designs may be Waterjet cut or Laser cut as per requirement. Some designs may come with borders.

For detailed information kindly consult our sales personnel.

Note: The displayed illustration is for orientation only. Actual pattern may vary from the pattern shown.

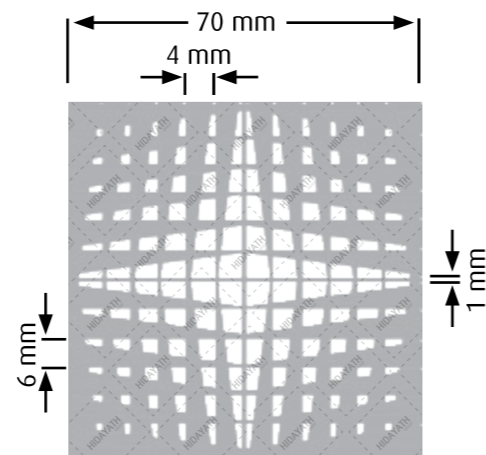

CODE
HTC 1111

Full sheet pattern orientation -
white areas are etched.
Maximum Size: 8ft. x 4ft. (Etching)

Different finishes and colours are available on request.

Designs may be Waterjet cut or Laser cut as per requirement. Some designs may come with borders.

For detailed information kindly consult our sales personnel.

Note: The displayed illustration is for orientation only. Actual pattern may vary from the pattern shown.

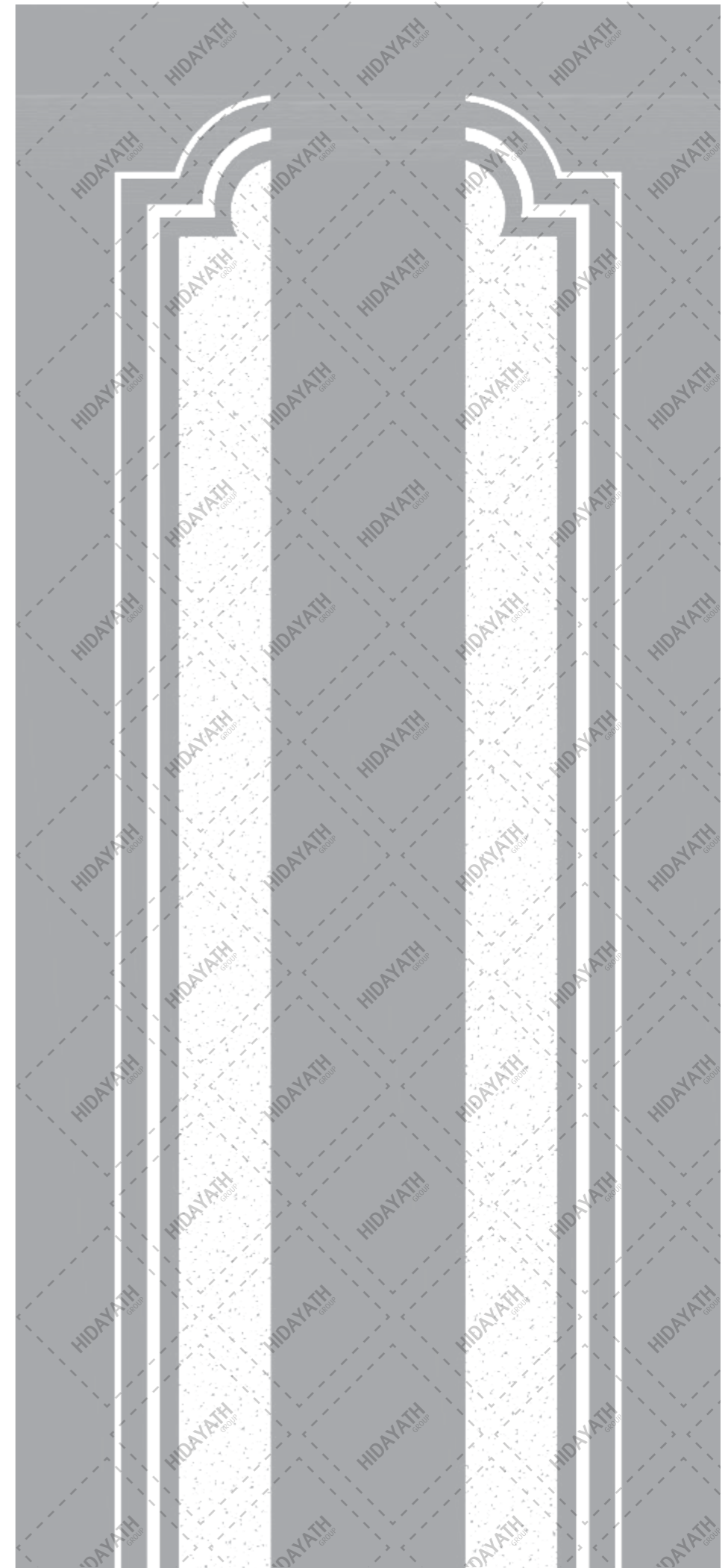
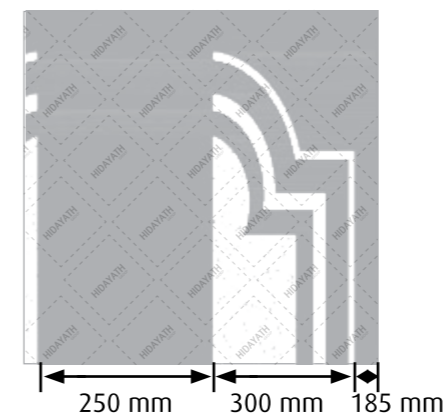

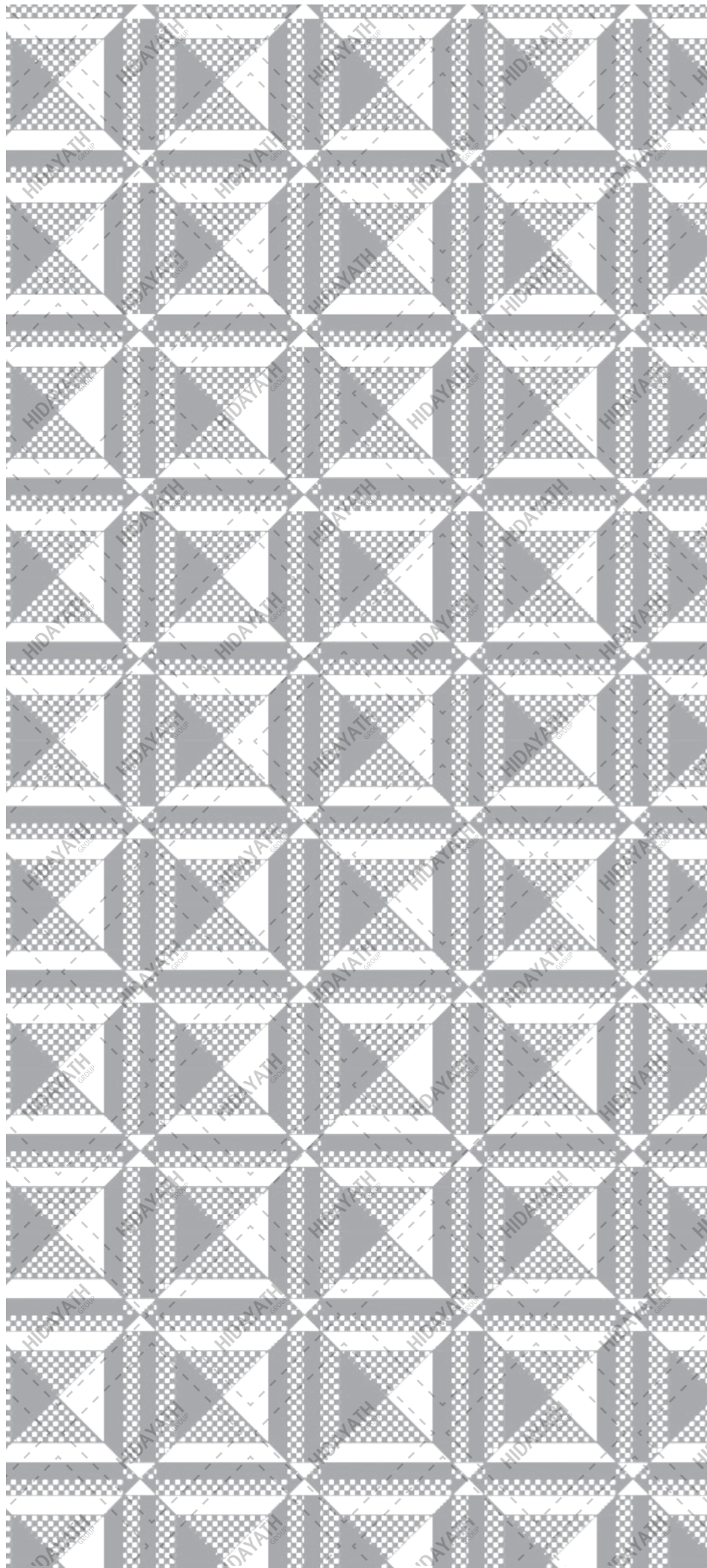

CODE
HTC 1112

Full sheet pattern orientation
white areas are etched.
Maximum Size: 8ft. x 4ft. (Etching)

Different finishes and colours are available on request.

Designs may be Waterjet cut or Laser cut as per requirement. Some designs may come with borders.

For detailed information kindly consult our sales personnel.

Note: The displayed illustration is for orientation only. Actual pattern may vary from the pattern shown.

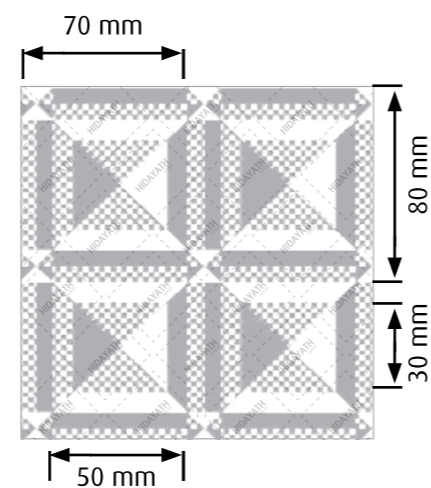

CODE
HTC 1113

Full sheet pattern orientation -
white areas are etched.
Maximum Size: 8ft. x 4ft. (Etching)

Different finishes and colours are available on request.

Designs may be Waterjet cut or Laser cut as per requirement. Some designs may come with borders.

For detailed information kindly consult our sales personnel.

Note: The displayed illustration is for orientation only. Actual pattern may vary from the pattern shown.

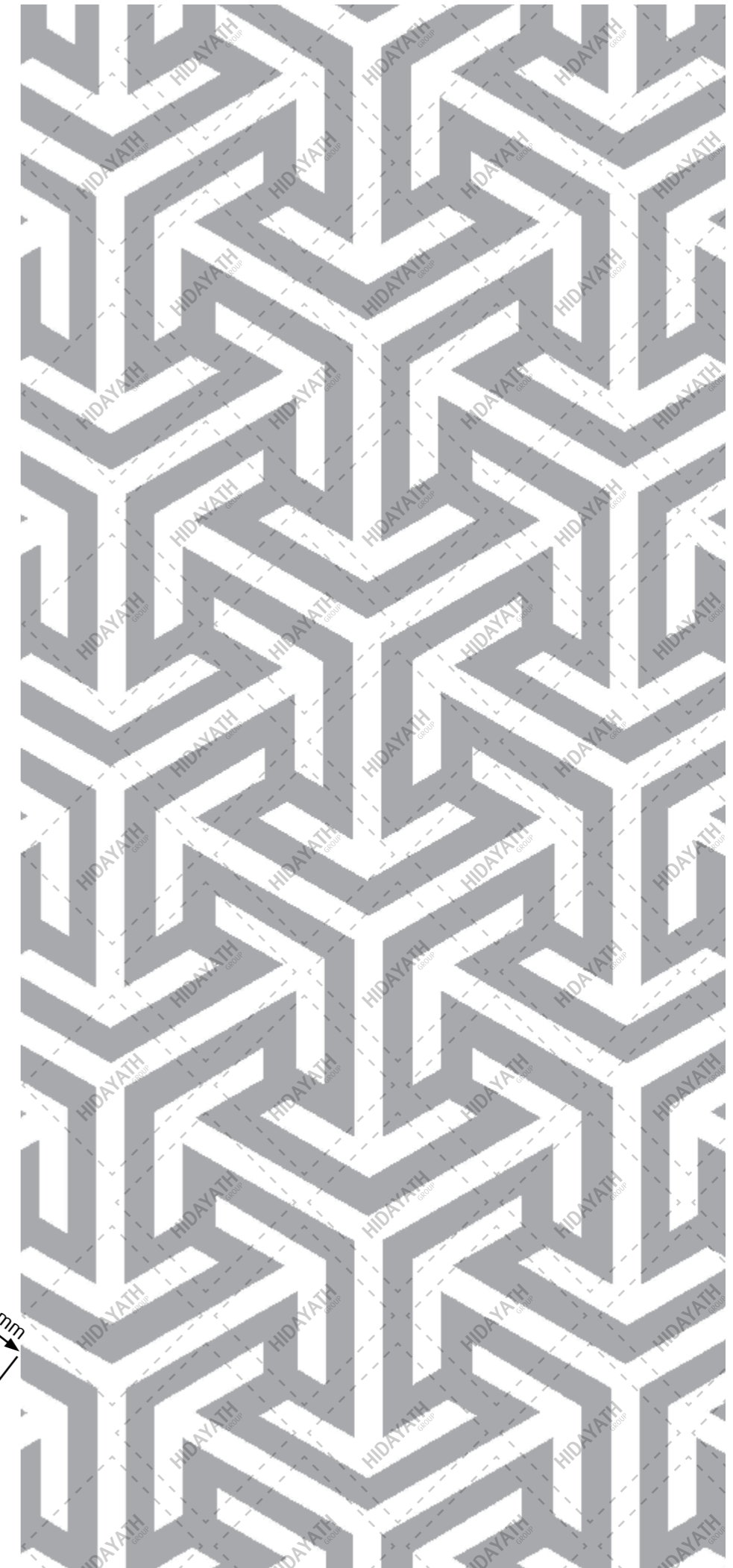
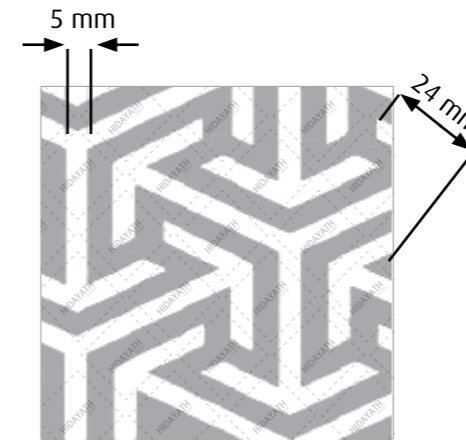

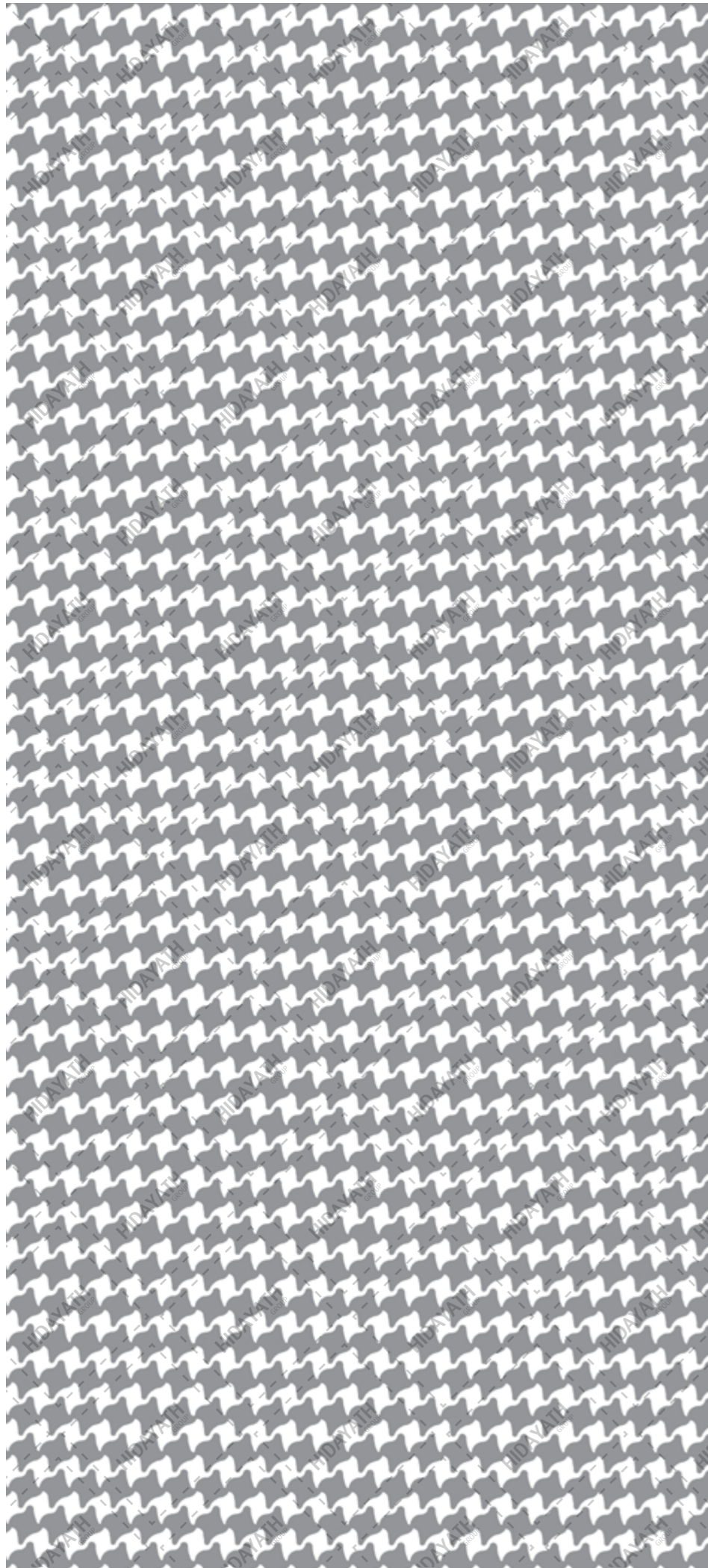

CODE
HTC 1114

Full sheet pattern orientation - **white** areas are etched.
Maximum Size: 8ft. x 4ft. (Etching)

Different finishes and colours are available on request.

Designs may be Waterjet cut or Laser cut as per requirement. Some designs may come with borders.

For detailed information kindly consult our sales personnel.

Note: The displayed illustration is for orientation only. Actual pattern may vary from the pattern shown.

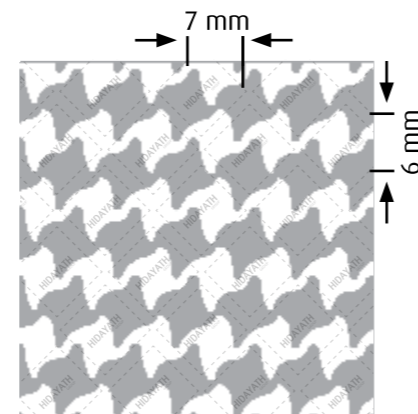

CODE
HTC 1115

Full sheet pattern orientation - **white** areas are etched.
Maximum Size: 8ft. x 4ft. (Etching)

Different finishes and colours are available on request.

Designs may be Waterjet cut or Laser cut as per requirement. Some designs may come with borders.

For detailed information kindly consult our sales personnel.

Note: The displayed illustration is for orientation only. Actual pattern may vary from the pattern shown.





CODE
HTC 1116

Full sheet pattern orientation - **white** areas are etched.
 Maximum Size: 8ft. x 4ft. (Etching)

Different finishes and colours are available on request.

Designs may be Waterjet cut or Laser cut as per requirement. Some designs may come with borders.

For detailed information kindly consult our sales personnel.

Note: The displayed illustration is for orientation only. Actual pattern may vary from the pattern shown.

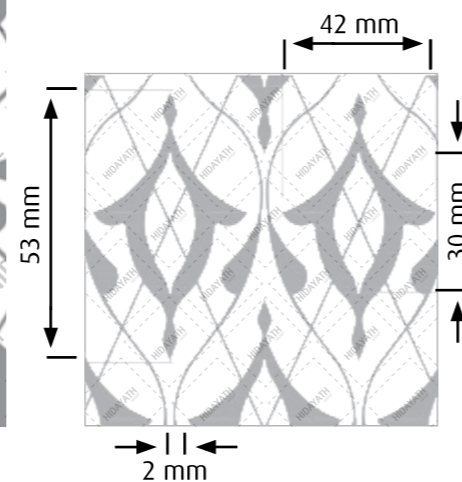

CODE
HTC 1117

Full sheet pattern orientation - **white** areas are etched.
 Maximum Size: 8ft. x 4ft. (Etching)

Different finishes and colours are available on request.

Designs may be Waterjet cut or Laser cut as per requirement. Some designs may come with borders.

For detailed information kindly consult our sales personnel.

Note: The displayed illustration is for orientation only. Actual pattern may vary from the pattern shown.

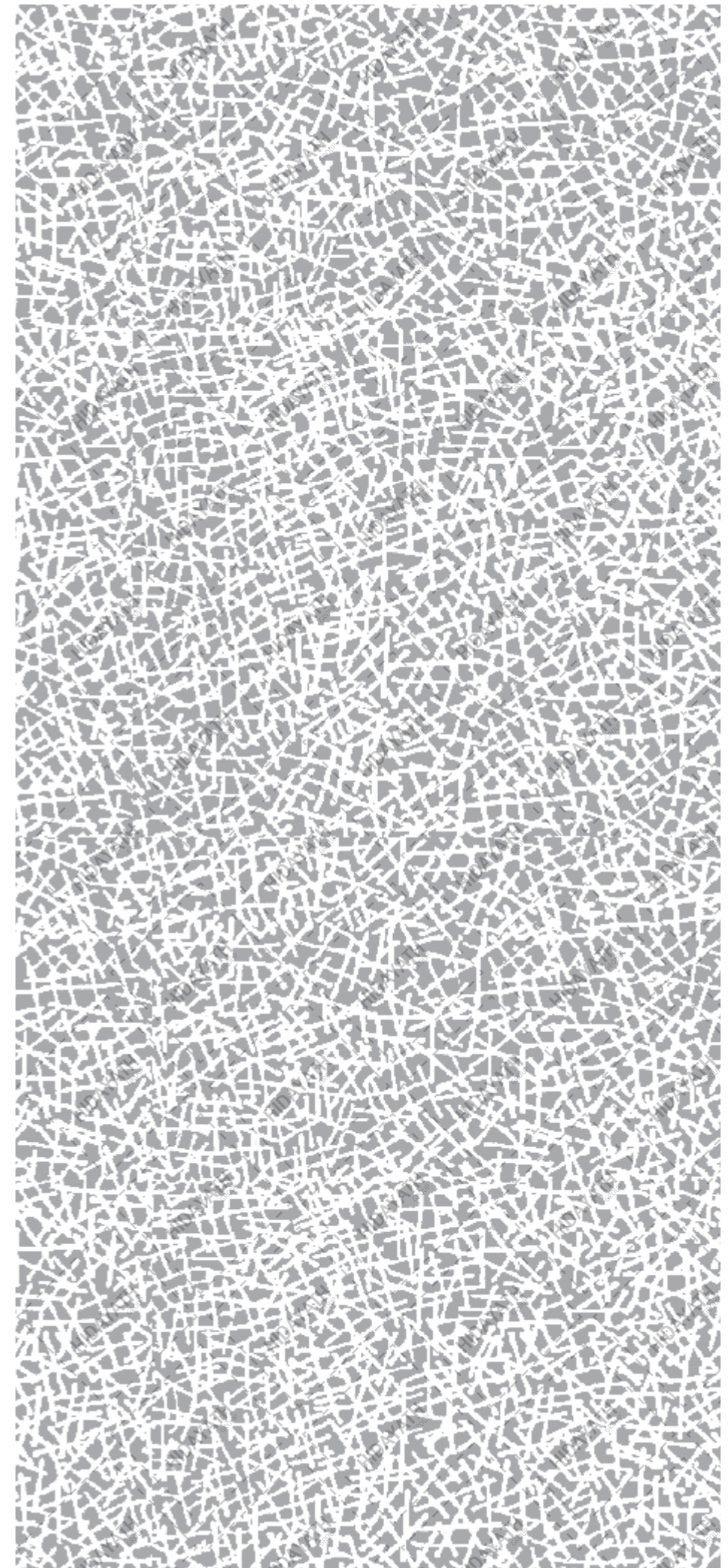
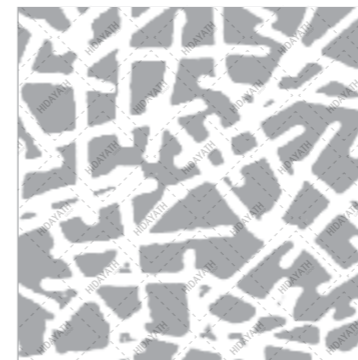

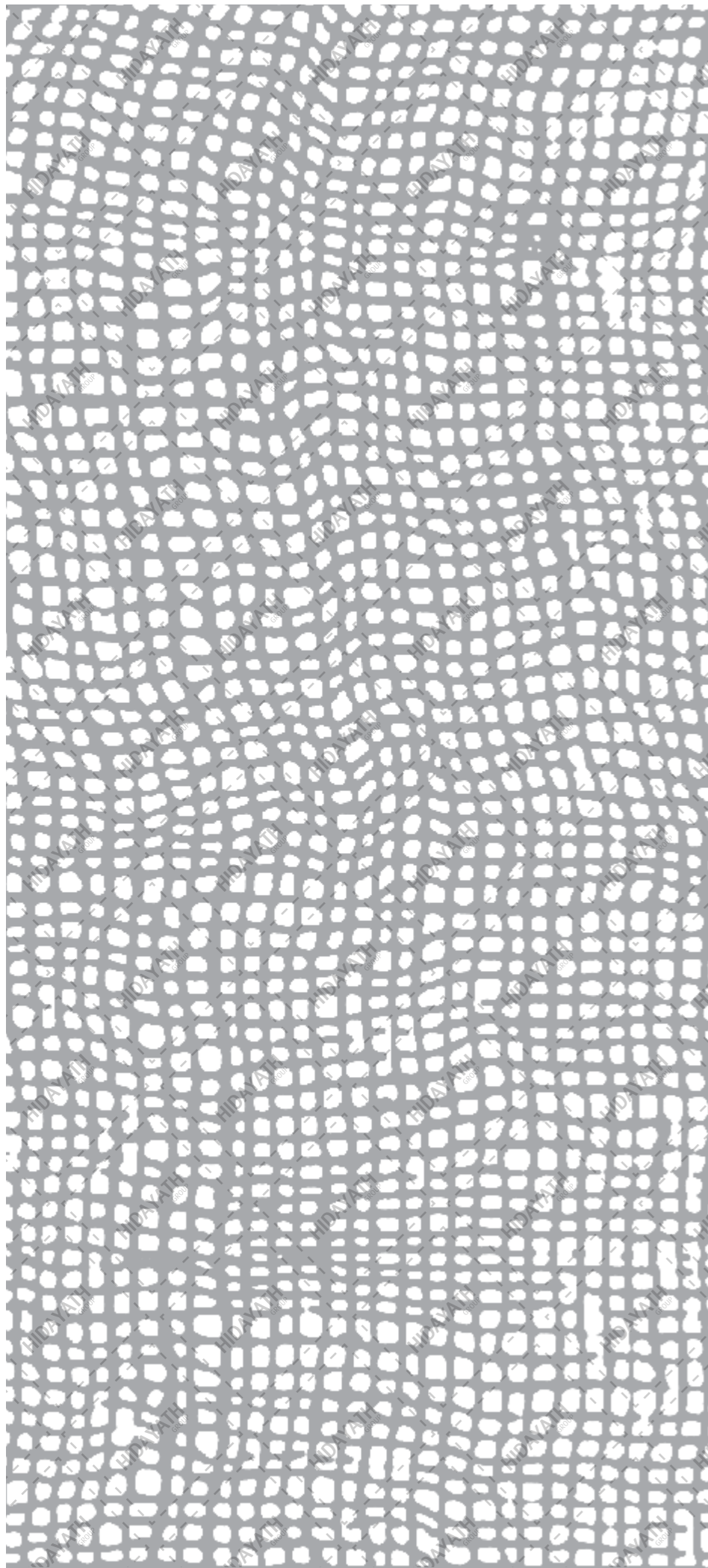

CODE
HTC 1118

Full sheet pattern orientation - **white** areas are etched.
Maximum Size: 8ft. x 4ft. (Etching)

Different finishes and colours are available on request.

Designs may be Waterjet cut or Laser cut as per requirement. Some designs may come with borders.

For detailed information kindly consult our sales personnel.

Note: The displayed illustration is for orientation only. Actual pattern may vary from the pattern shown.

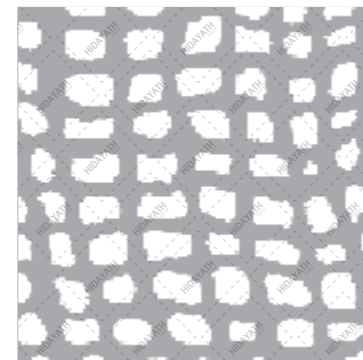

CODE
HTC 1119

Full sheet pattern orientation - **white** areas are etched.
Maximum Size: 8ft. x 4ft. (Etching)

Different finishes and colours are available on request.

Designs may be Waterjet cut or Laser cut as per requirement. Some designs may come with borders.

For detailed information kindly consult our sales personnel.

Note: The displayed illustration is for orientation only. Actual pattern may vary from the pattern shown.

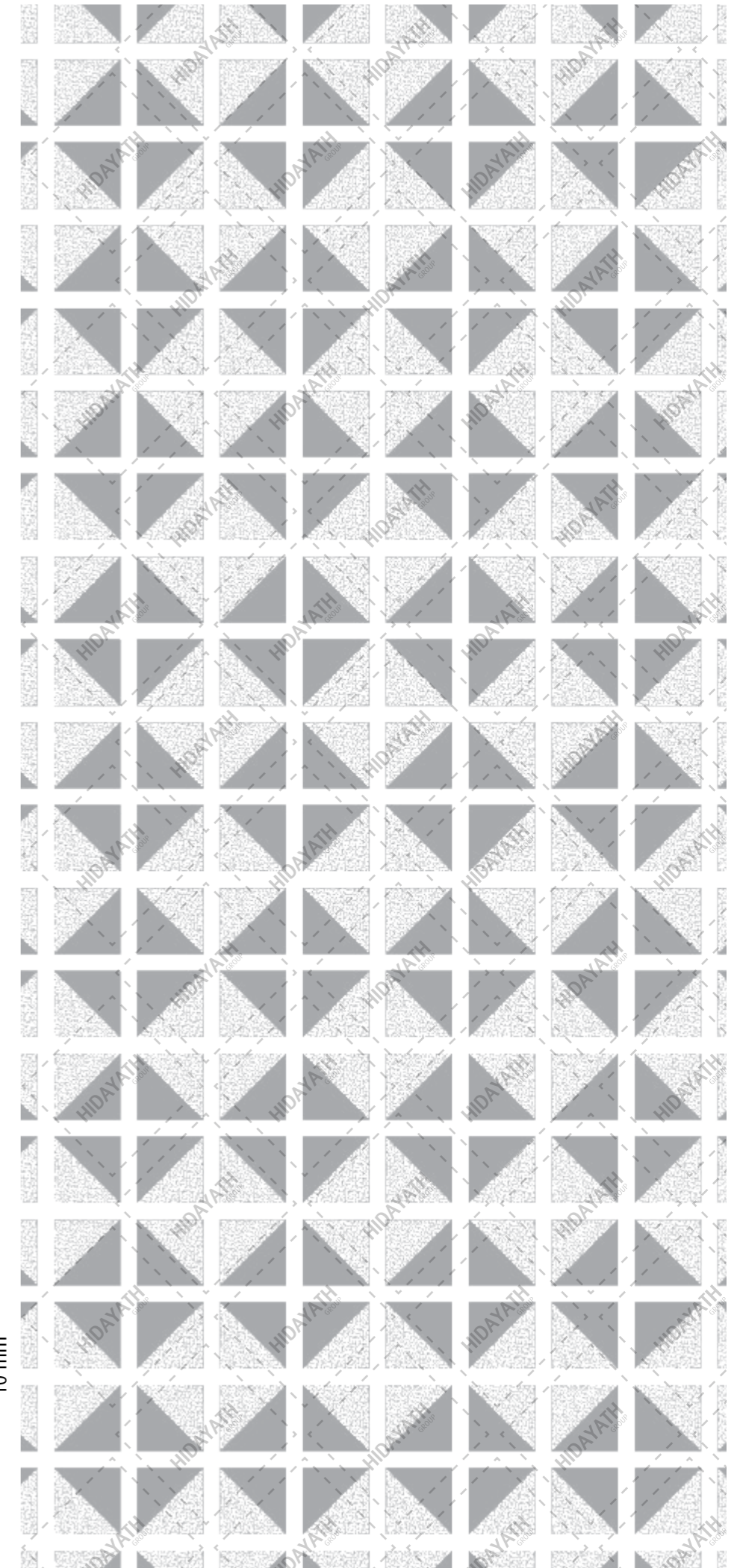
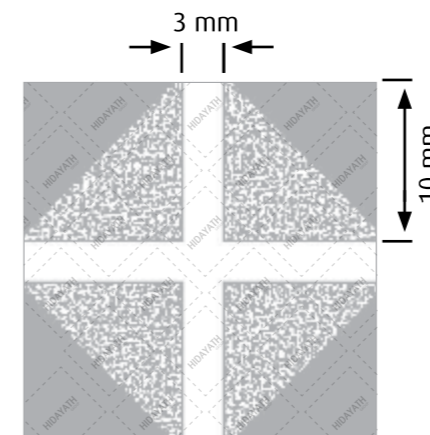

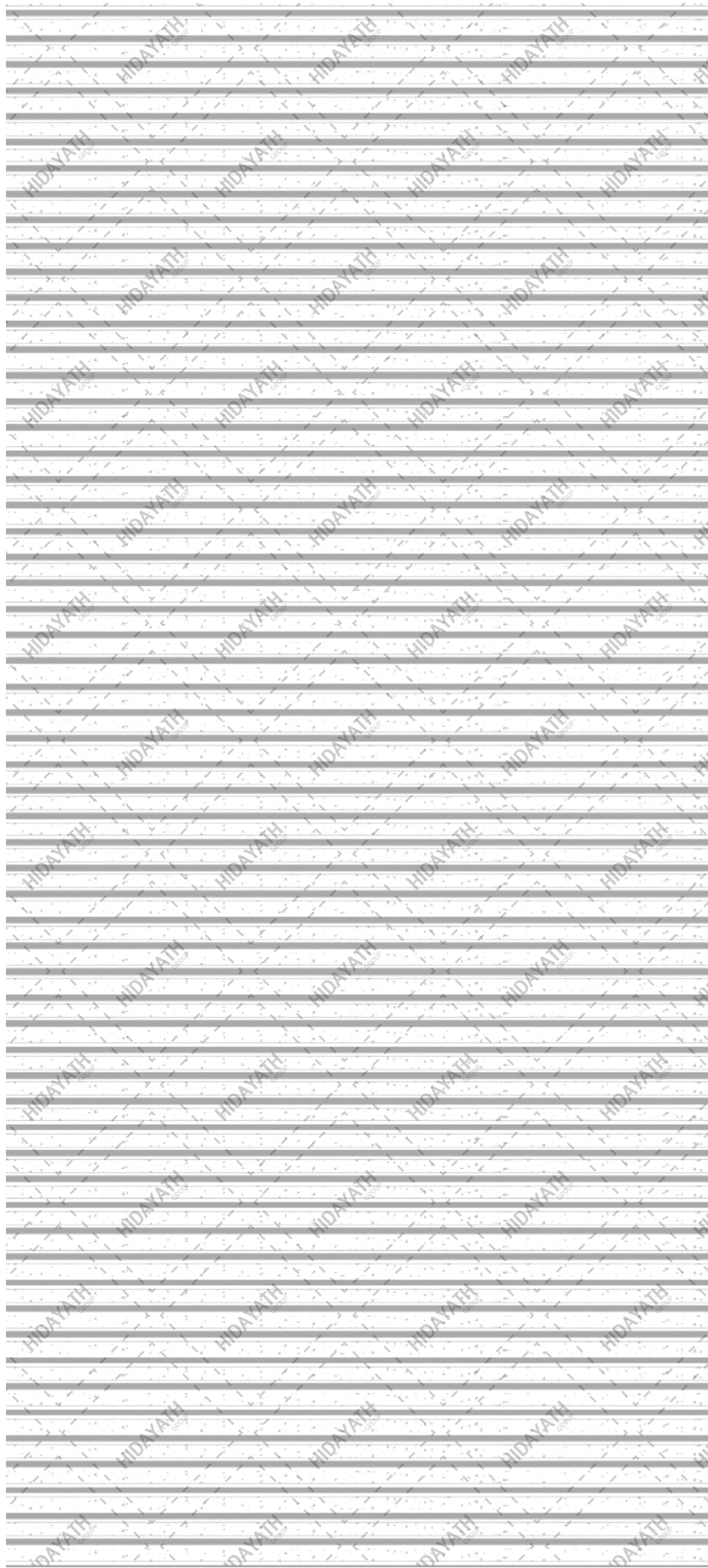

CODE
HTC 1120

Full sheet pattern orientation - **white** areas are etched.
Maximum Size: 8ft. x 4ft. (Etching)

Different finishes and colours are available on request.

Designs may be Waterjet cut or Laser cut as per requirement. Some designs may come with borders.

For detailed information kindly consult our sales personnel.

Note: The displayed illustration is for orientation only. Actual pattern may vary from the pattern shown.

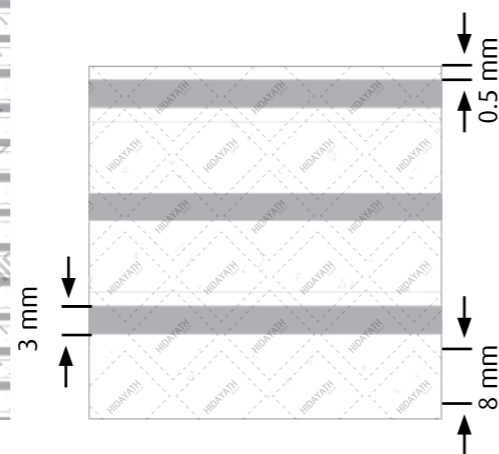

CODE
HTC 1121

Full sheet pattern orientation - **white** areas are etched.
Maximum Size: 8ft. x 4ft. (Etching)

Different finishes and colours are available on request.

Designs may be Waterjet cut or Laser cut as per requirement. Some designs may come with borders.

For detailed information kindly consult our sales personnel.

Note: The displayed illustration is for orientation only. Actual pattern may vary from the pattern shown.

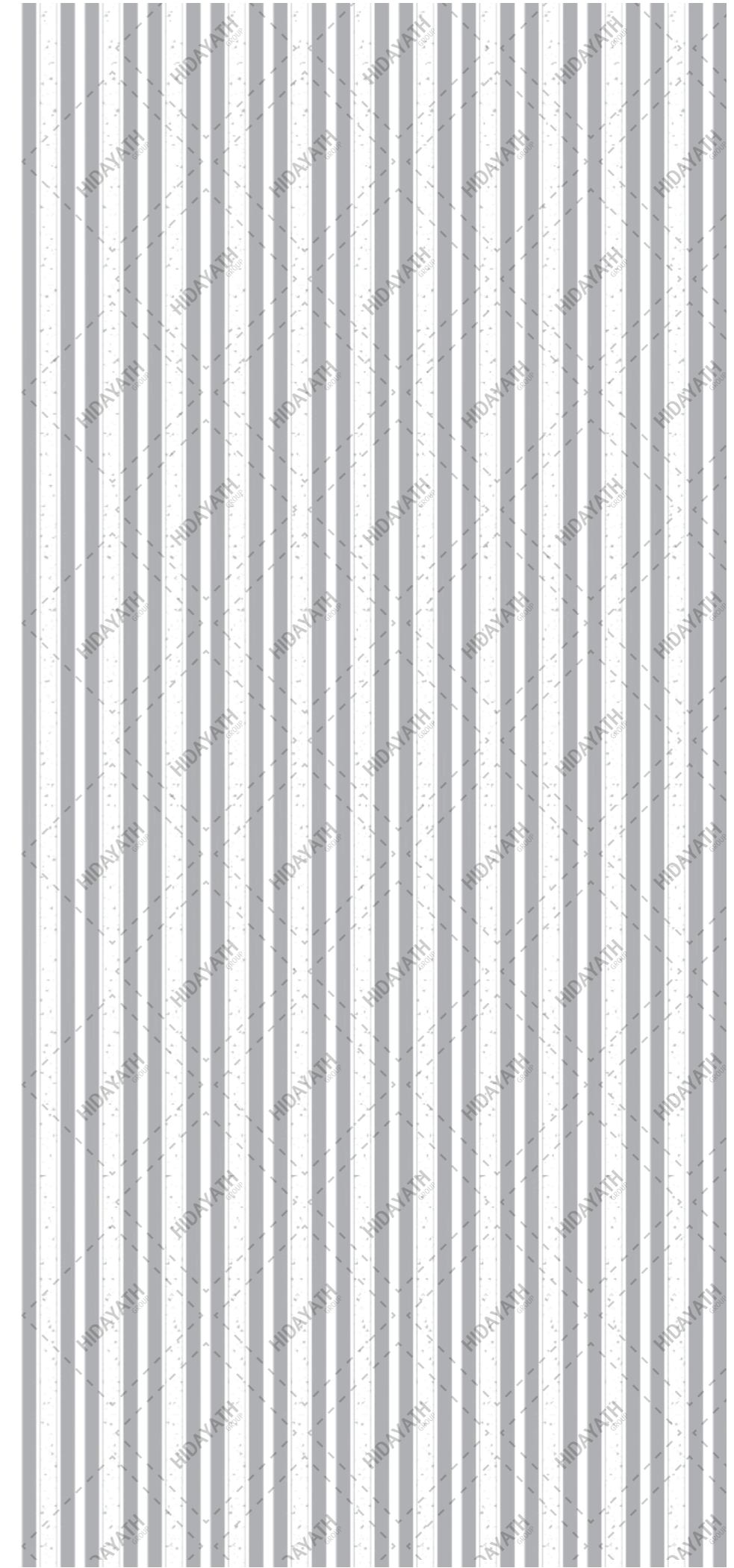
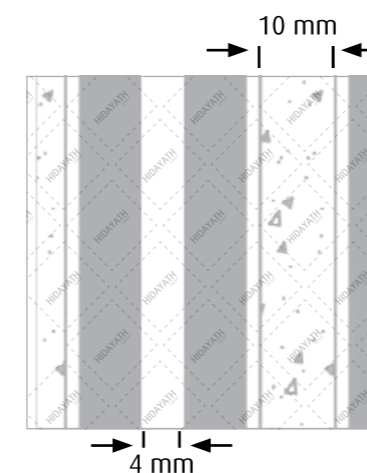

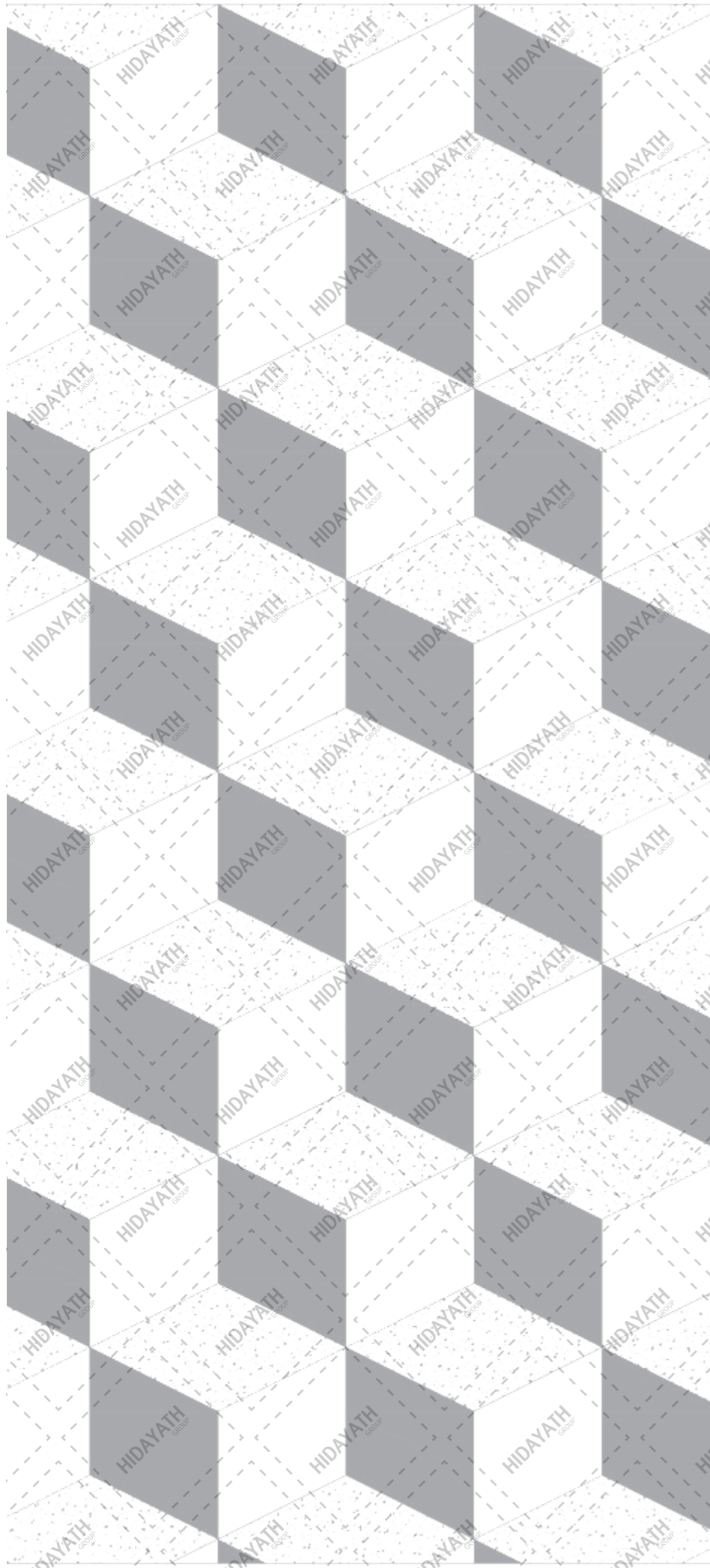

CODE
HTC 1122

Full sheet pattern orientation - **white** areas are etched.
Maximum Size: 8ft. x 4ft. (Etching)

Different finishes and colours are available on request.

Designs may be Waterjet cut or Laser cut as per requirement. Some designs may come with borders.

For detailed information kindly consult our sales personnel.

Note: The displayed illustration is for orientation only. Actual pattern may vary from the pattern shown.

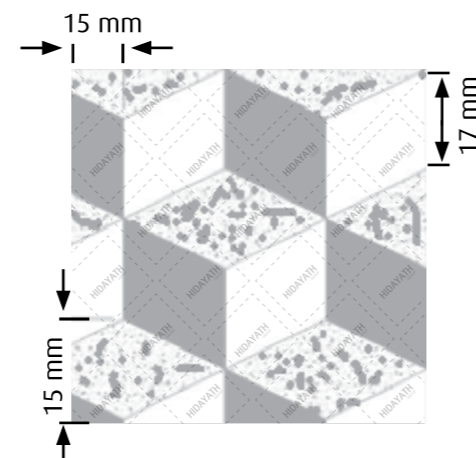

CODE
HTC 1123

Full sheet pattern orientation - **white** areas are etched.
Maximum Size: 8ft. x 4ft. (Etching)

Different finishes and colours are available on request.

Designs may be Waterjet cut or Laser cut as per requirement. Some designs may come with borders.

For detailed information kindly consult our sales personnel.

Note: The displayed illustration is for orientation only. Actual pattern may vary from the pattern shown.

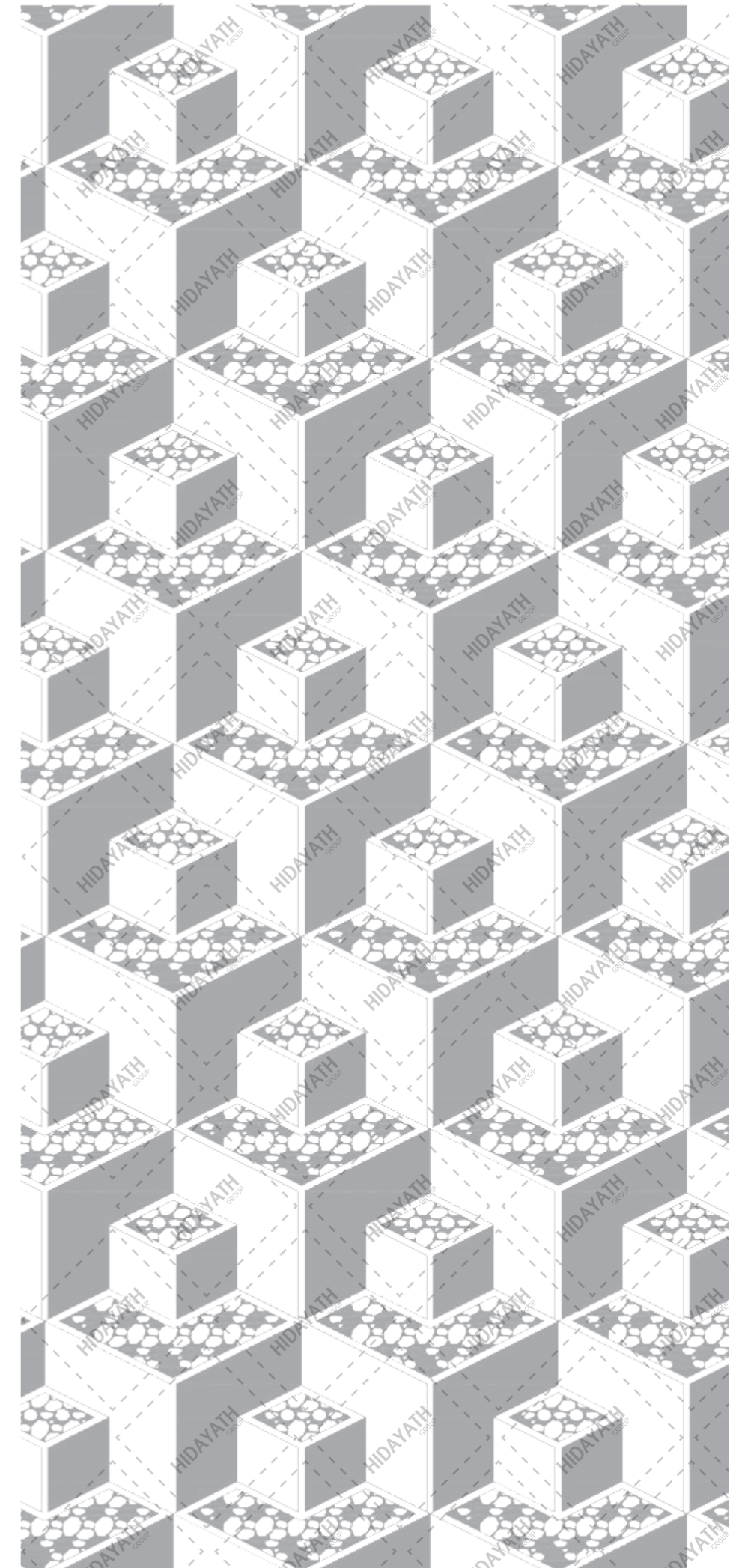
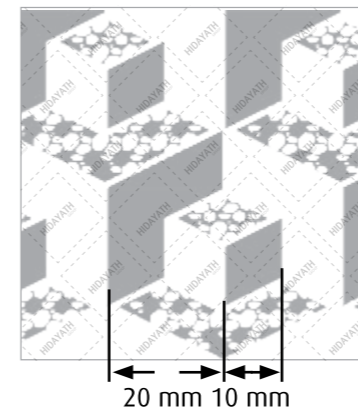

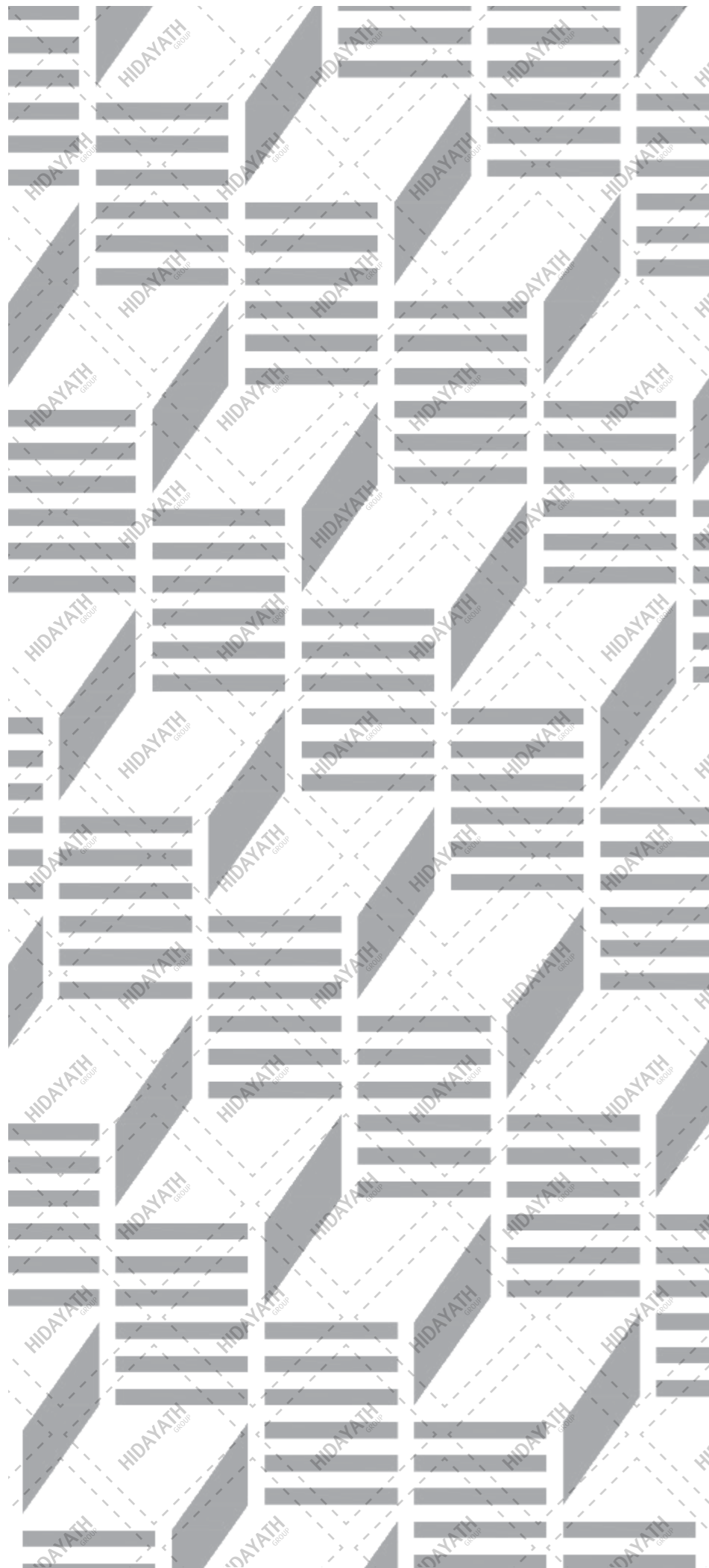

CODE
HTC 1124

Full sheet pattern orientation - **white** areas are etched.
Maximum Size: 8ft. x 4ft. (Etching)

Different finishes and colours are available on request.

Designs may be Waterjet cut or Laser cut as per requirement. Some designs may come with borders.

For detailed information kindly consult our sales personnel.

Note: The displayed illustration is for orientation only. Actual pattern may vary from the pattern shown.

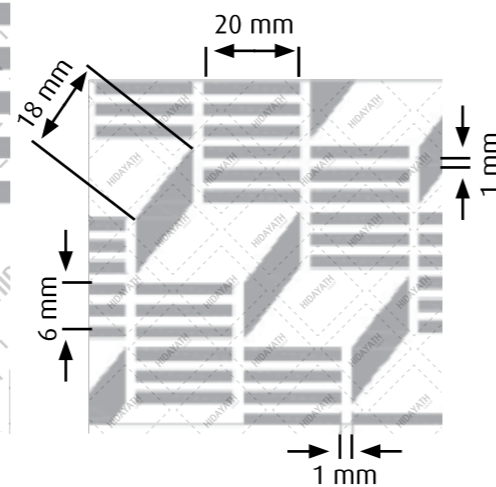

CODE
HTC 1125

Full sheet pattern orientation - **white** areas are etched.
Maximum Size: 8ft. x 4ft. (Etching)

Different finishes and colours are available on request.

Designs may be Waterjet cut or Laser cut as per requirement. Some designs may come with borders.

For detailed information kindly consult our sales personnel.

Note: The displayed illustration is for orientation only. Actual pattern may vary from the pattern shown.

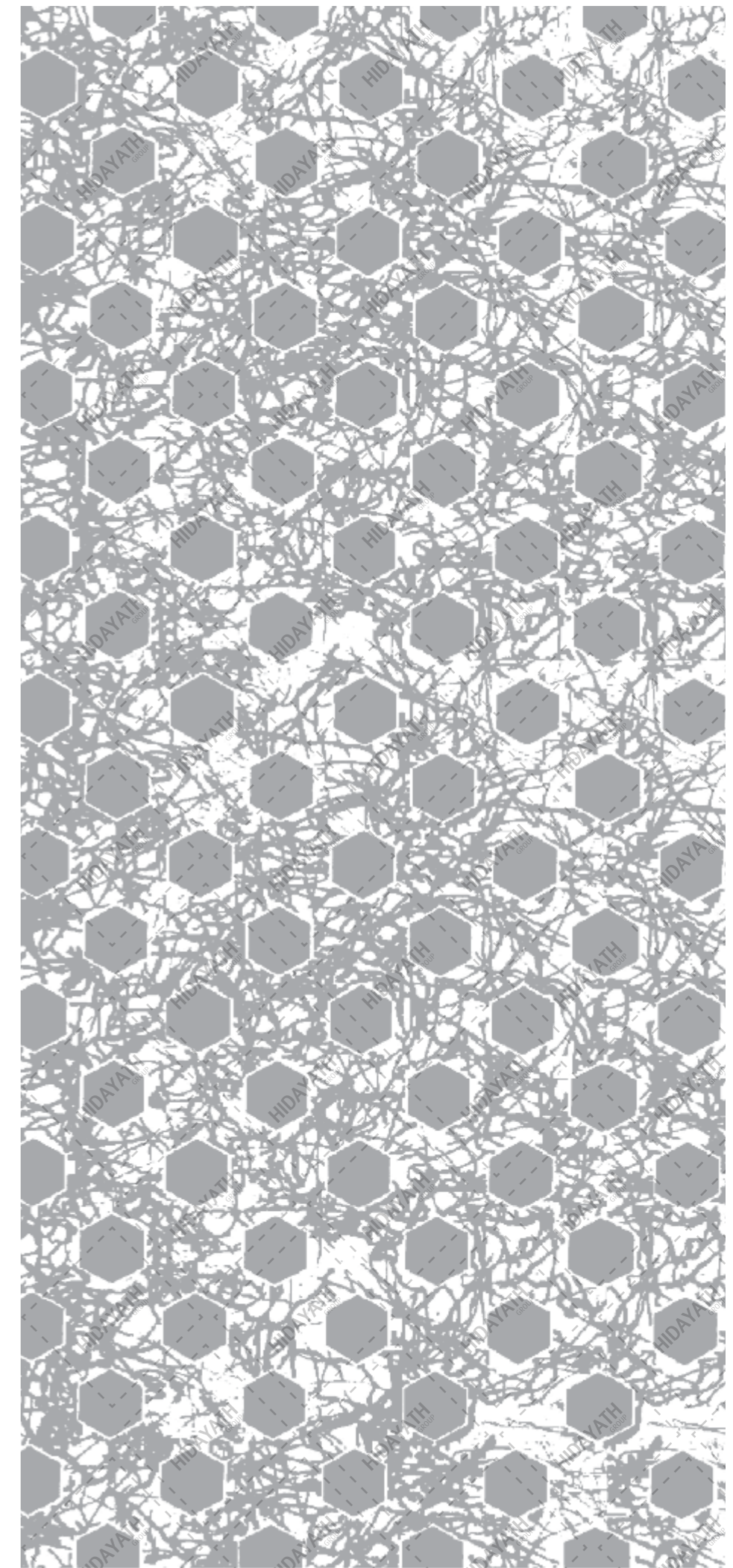
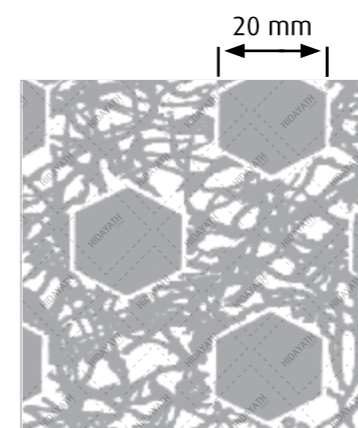

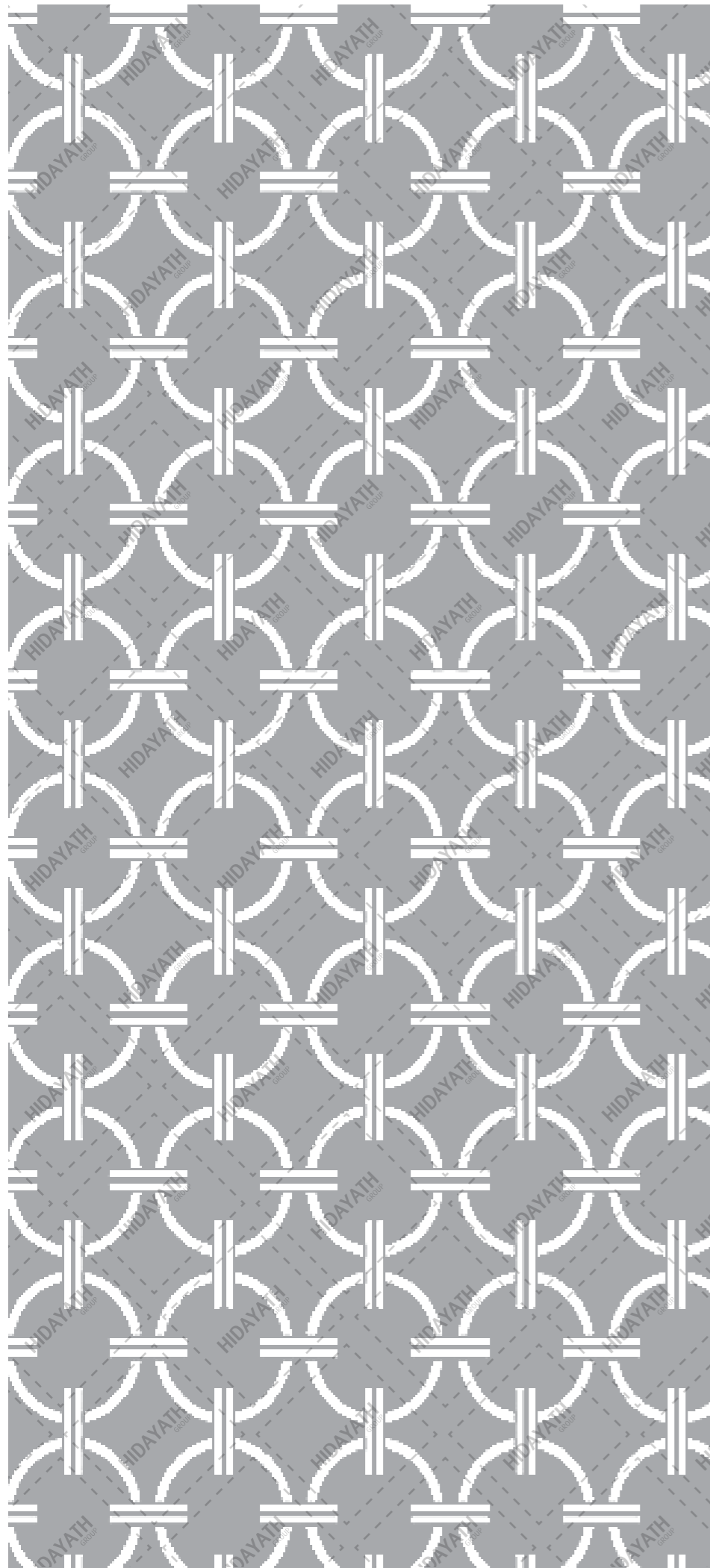

CODE
HTC 1126

Full sheet pattern orientation
white areas are etched.
Maximum Size: 8ft. x 4ft. (Etching)

Different finishes and colours are available on request.

Designs may be Waterjet cut or Laser cut as per requirement. Some designs may come with borders.

For detailed information kindly consult our sales personnel.

Note: The displayed illustration is for orientation only. Actual pattern may vary from the pattern shown.

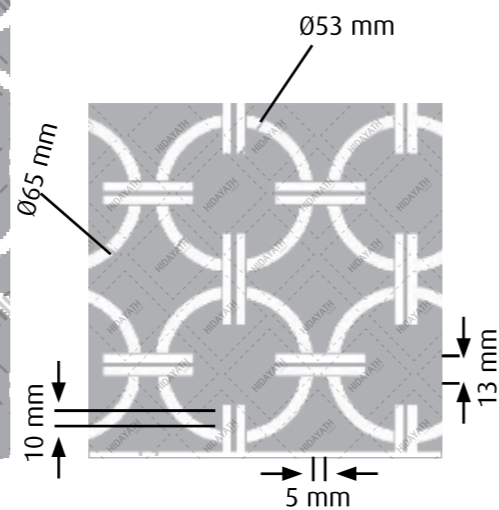

CODE
HTC 1127

Full sheet pattern orientation -
white areas are etched.
Maximum Size: 8ft. x 4ft. (Etching)

Different finishes and colours are available on request.

Designs may be Waterjet cut or Laser cut as per requirement. Some designs may come with borders.

For detailed information kindly consult our sales personnel.

Note: The displayed illustration is for orientation only. Actual pattern may vary from the pattern shown.

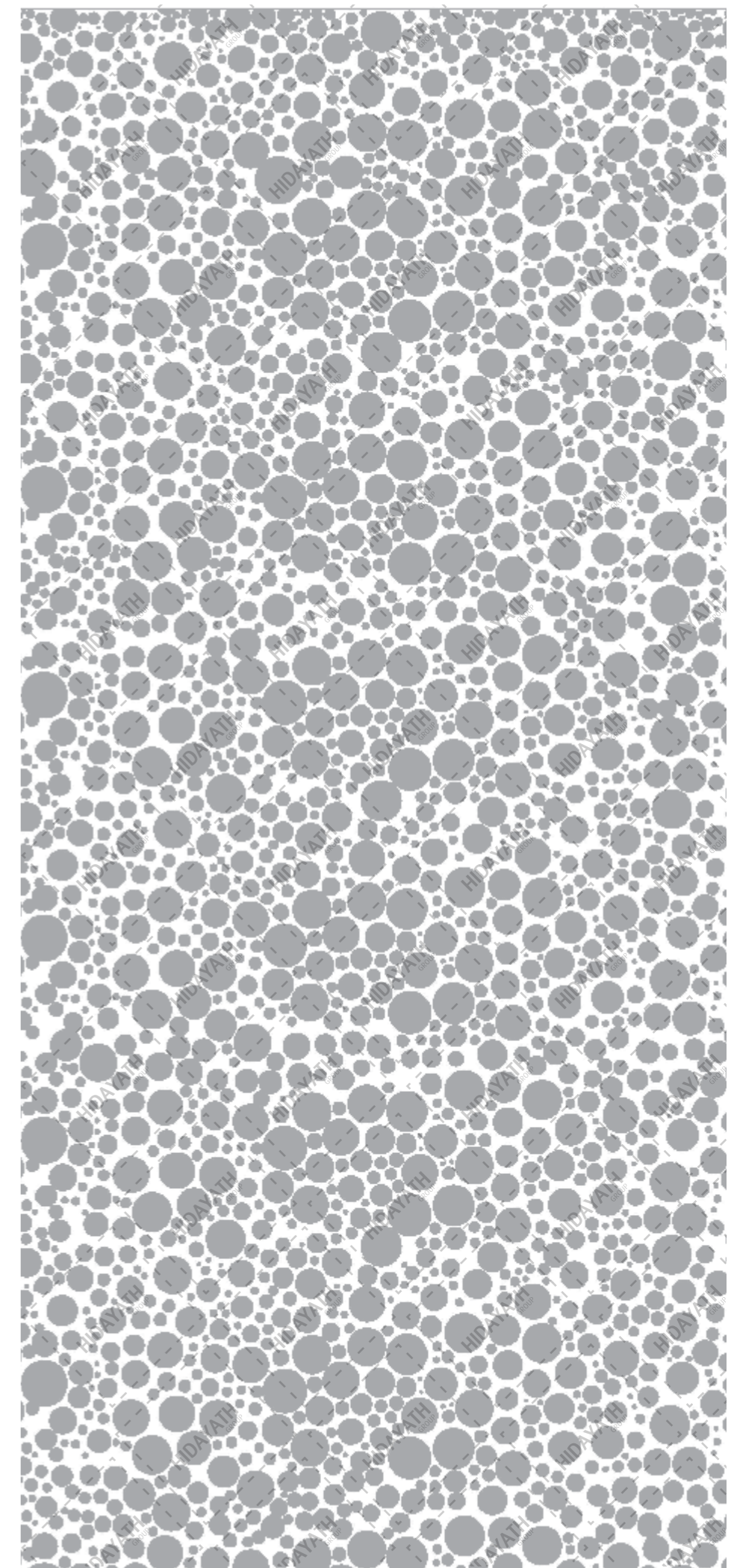
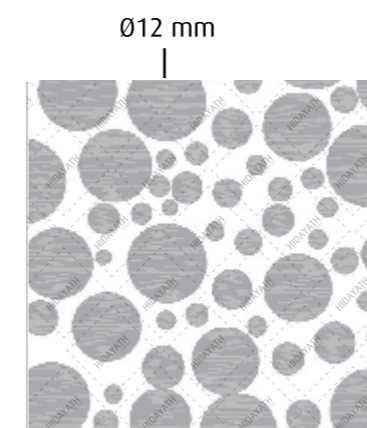

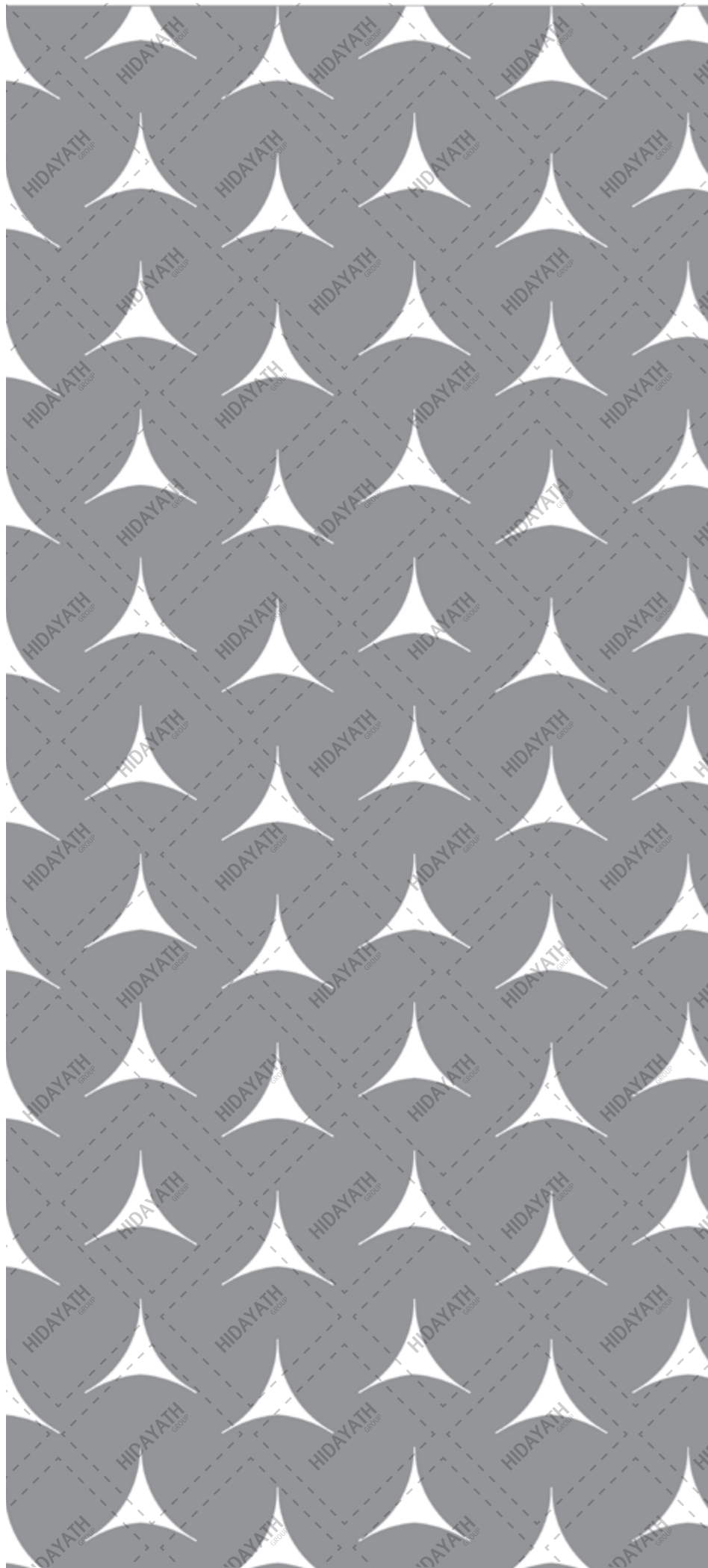

CODE
HTC 1128

Full sheet pattern orientation
white areas are etched.
Maximum Size: 8ft. x 4ft. (Etching)

Different finishes and colours are available on request.

Designs may be Waterjet cut or Laser cut as per requirement. Some designs may come with borders.

For detailed information kindly consult our sales personnel.

Note: The displayed illustration is for orientation only. Actual pattern may vary from the pattern shown.

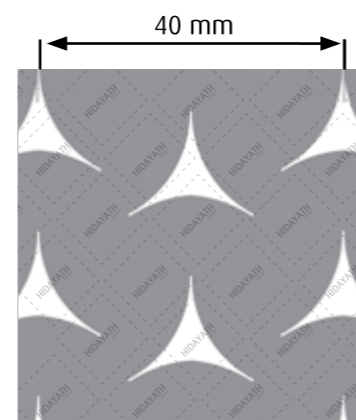

CODE
HTC 1129

Full sheet pattern orientation -
white areas are etched.
Maximum Size: 8ft. x 4ft. (Etching)

Different finishes and colours are available on request.

Designs may be Waterjet cut or Laser cut as per requirement. Some designs may come with borders.

For detailed information kindly consult our sales personnel.

Note: The displayed illustration is for orientation only. Actual pattern may vary from the pattern shown.

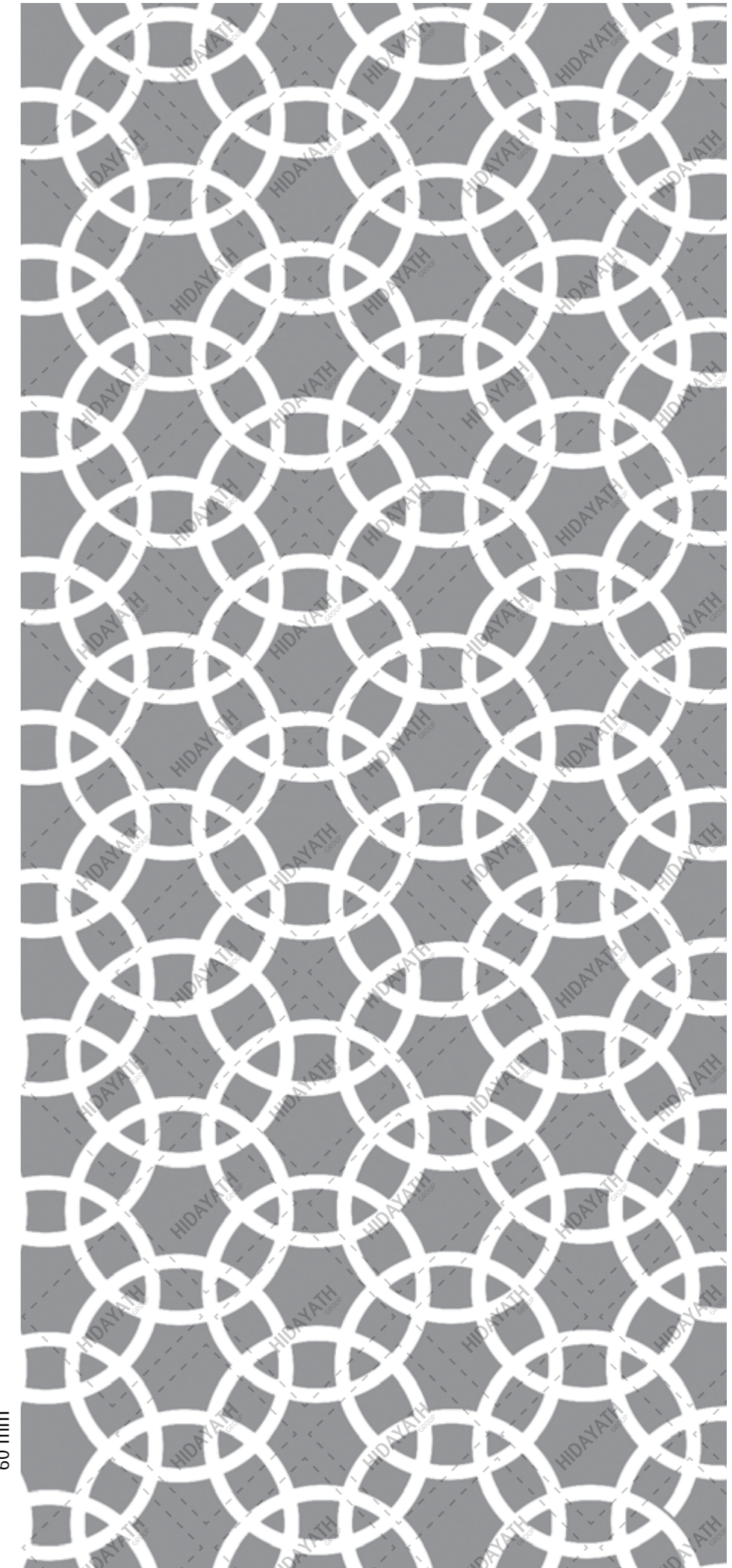
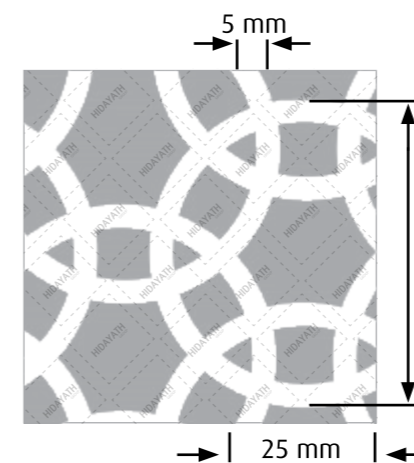

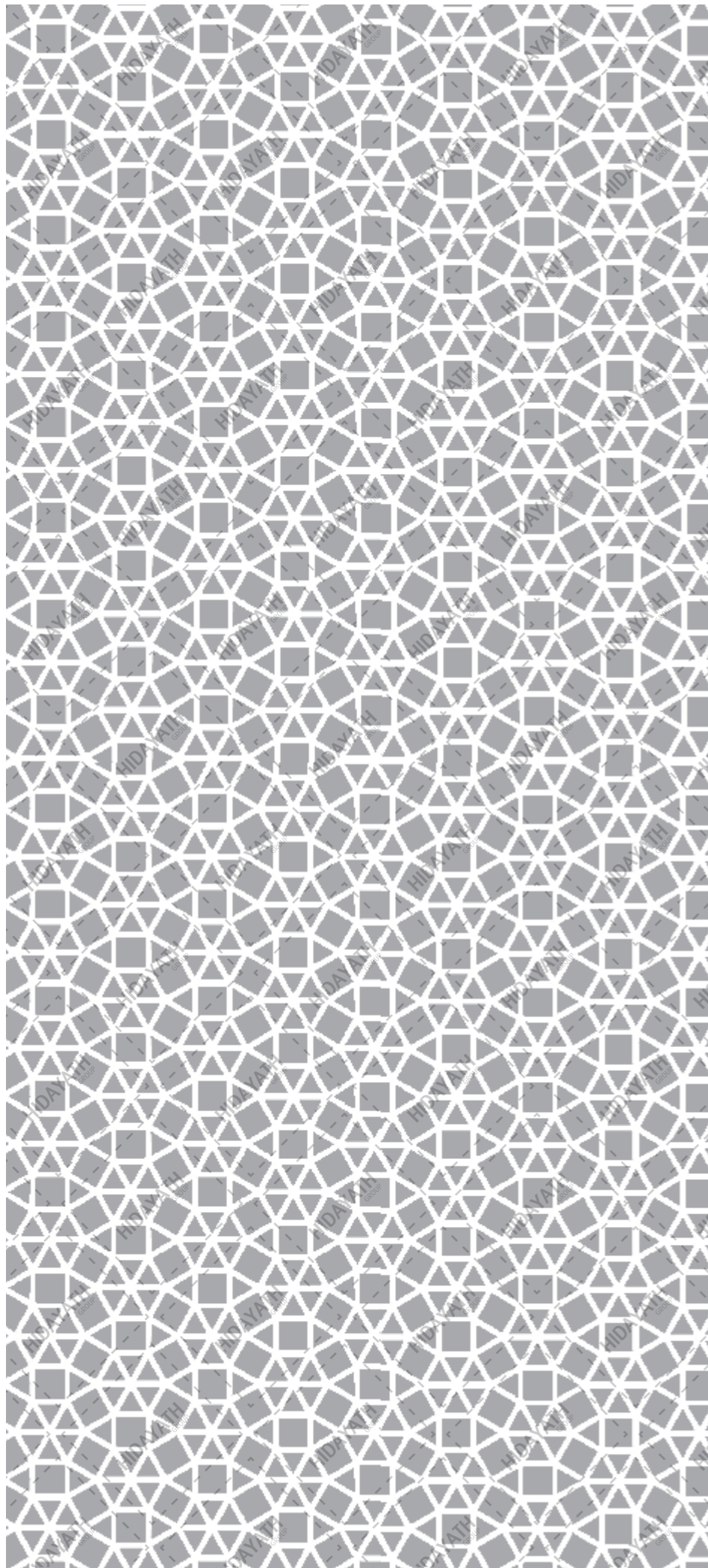

CODE
HTC 1130

Full sheet pattern orientation - **white** areas are etched.
Maximum Size: 8ft. x 4ft. (Etching)

Different finishes and colours are available on request.

Designs may be Waterjet cut or Laser cut as per requirement. Some designs may come with borders.

For detailed information kindly consult our sales personnel.

Note: The displayed illustration is for orientation only. Actual pattern may vary from the pattern shown.

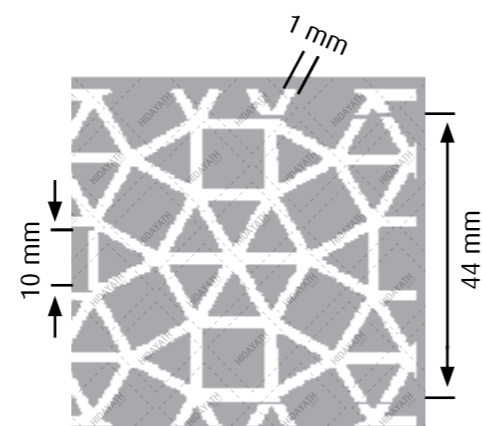

CODE
HTC 1131

Full sheet pattern orientation - **white** areas are etched.
Maximum Size: 8ft. x 4ft. (Etching)

Different finishes and colours are available on request.

Designs may be Waterjet cut or Laser cut as per requirement. Some designs may come with borders.

For detailed information kindly consult our sales personnel.

Note: The displayed illustration is for orientation only. Actual pattern may vary from the pattern shown.

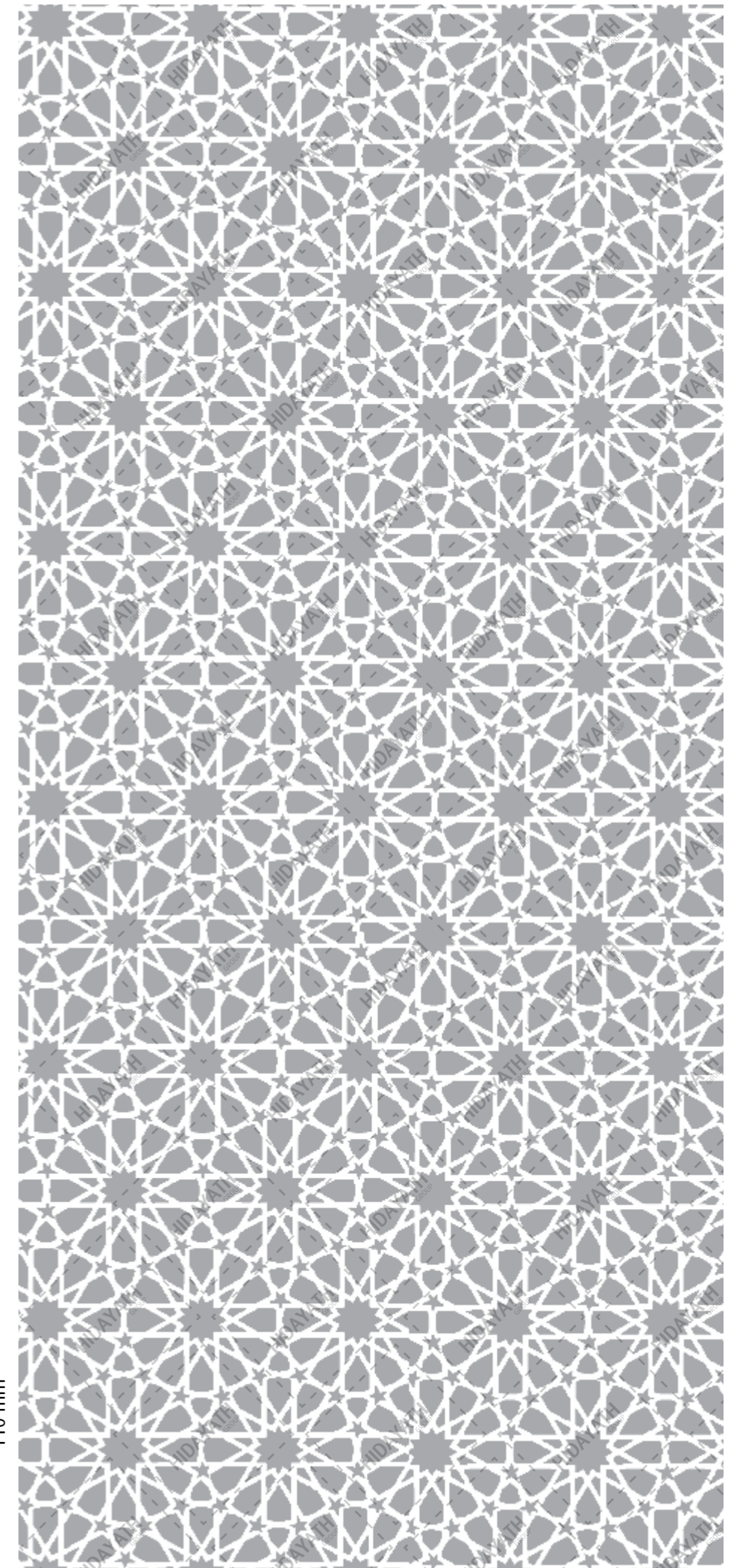
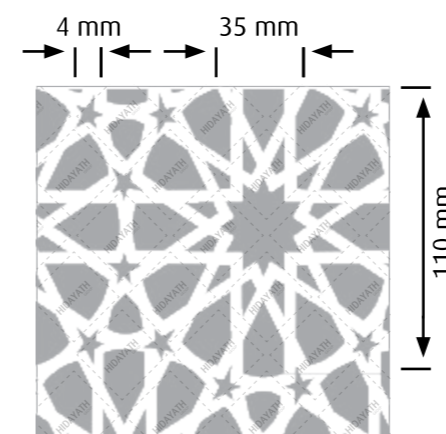

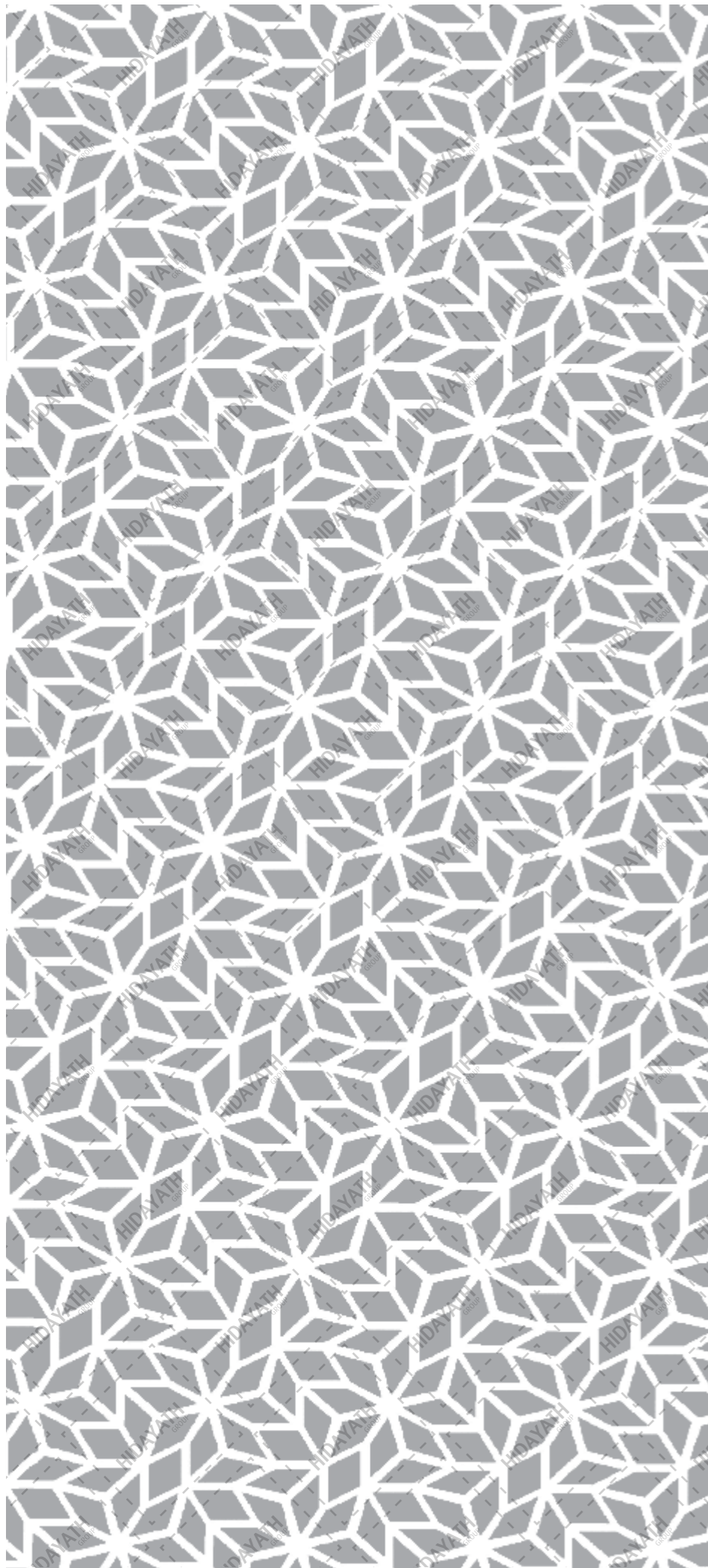

CODE
HTC 1132

Full sheet pattern orientation
white areas are etched.
Maximum Size: 8ft. x 4ft. (Etching)

Different finishes and colours are
available on request.

Designs may be Waterjet cut or
Laser cut as per requirement.
Some designs may come with
borders.

For detailed information kindly
consult our sales personnel.

Note: The displayed illustration is
for orientation only. Actual pattern
may vary from the pattern shown.

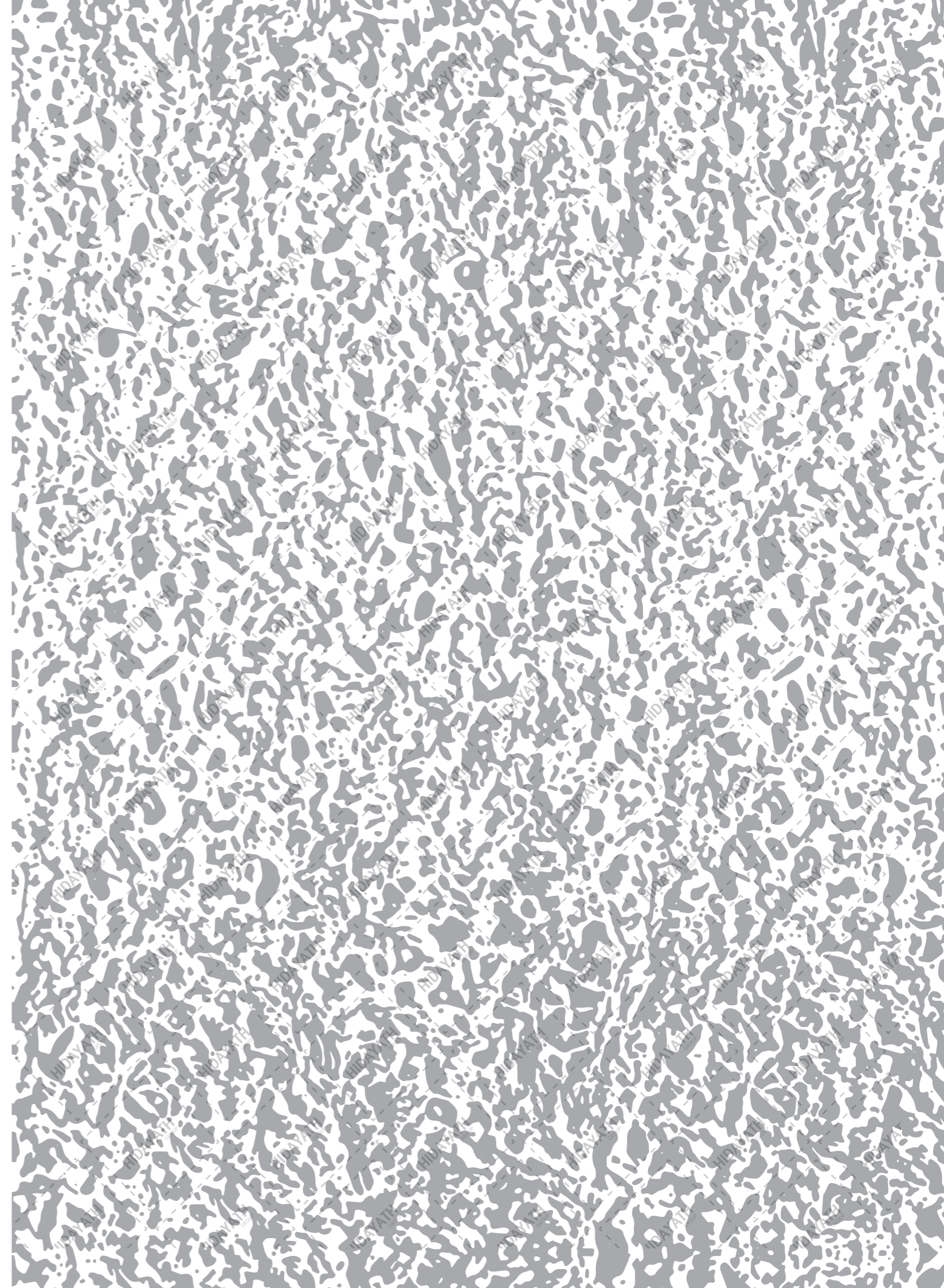
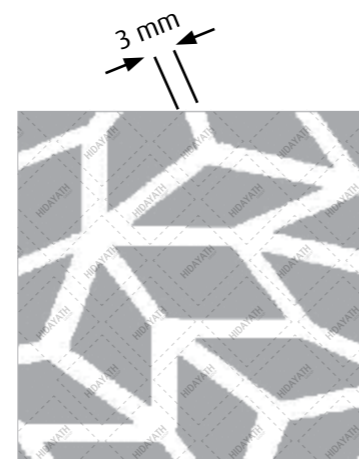

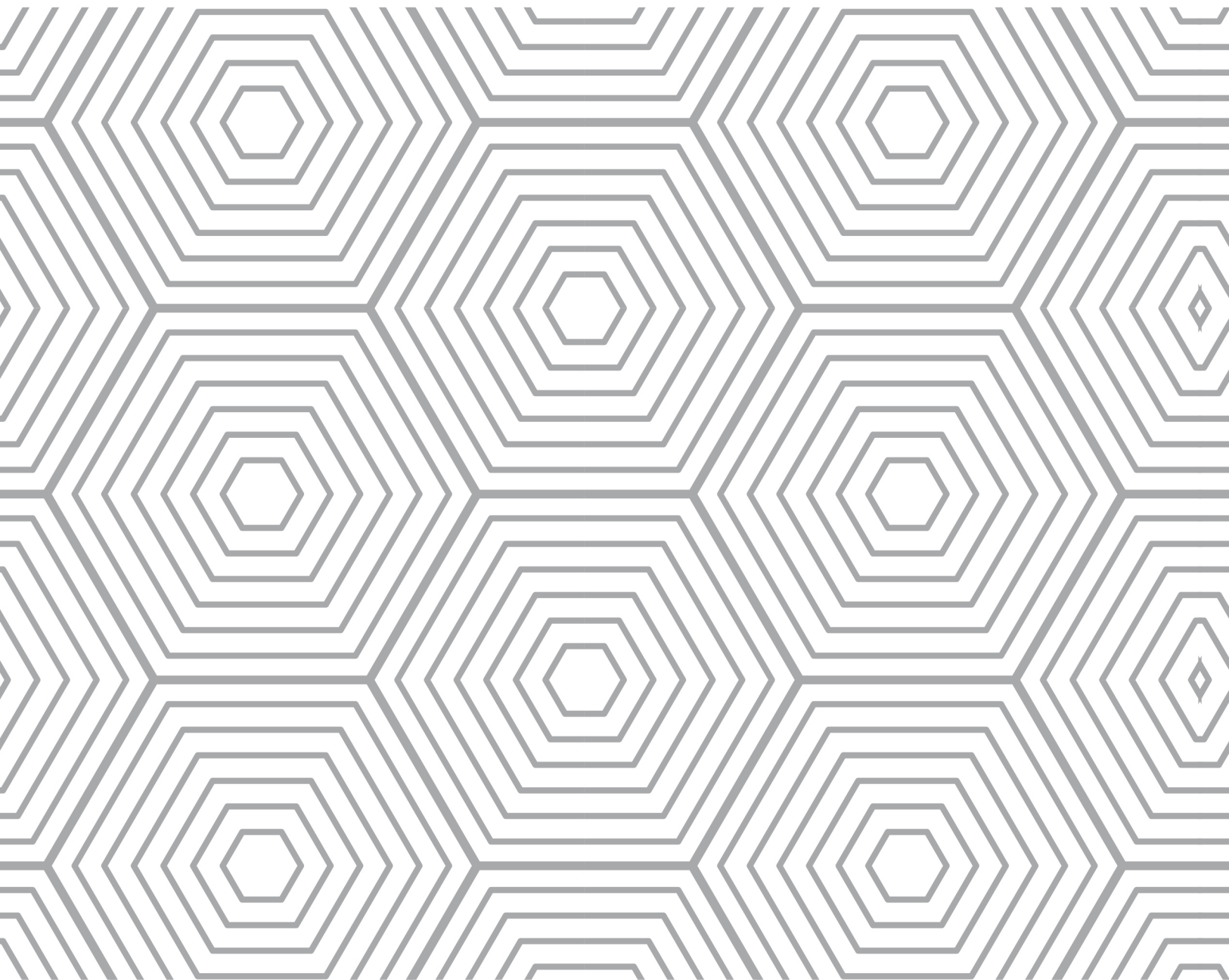

HIDAYATH

P.O. Box : 13650, Dubai, UAE
T: +971 4 885 77 00, F: +971 4 885 70 70
info@hidayath.com, www.hidayath.com

UAE | Oman | Qatar | Saudi Arabia | India